



Binding



Stability



Kinetics

MicroCal, LLC  
22 Industrial Drive East  
Northampton, MA 01060 USA  
Phone: +413 586 7720  
Fax: +413 586 0149  
[support@microcalorimetry.com](mailto:support@microcalorimetry.com)

---

# VP-ITC MicroCalorimeter

## User's Manual

---



# Table Of Contents

<b>General</b> .....	<b>i</b>
How To Use This Manual .....	i
How to Get Help From MicroCal.....	ii
<b>Section 1: VP-ITC System Introduction</b> .....	<b>1</b>
1.1 VP ITC – The Basics.....	2
1.2 Data Acquisition and Instrument Control.....	3
1.3 Suitable Laboratory Environment .....	4
1.4 VP-ITC Parts and Accessories .....	5
1.5 Setting Up the VP-ITC Instrument.....	7
1.6 Pipette Assembly.....	8
1.6 Pipette Assembly.....	9
1.7 The ThermoVac.....	11
<b>Section 2: VPViewer and Origin Software</b> .....	<b>14</b>
2.1 VPViewer and Origin Software Overview .....	15
2.2 Powering Up the VP-ITC Instrument.....	15
2.3 VPViewer Main Window .....	17
2.4 ITC Controls Window .....	21
2.5 Thermostat/Calibration Window .....	26
2.6 Setup/Maintenance Window.....	27
2.7 Constants Window.....	30
2.8 Real Time Data Display in Origin.....	31
2.9 ITC Cell Status .....	33
<b>Section 3: Running an ITC Experiment</b> .....	<b>35</b>
3.1 Designing ITC Experiments .....	36
3.2 Using the ThermoVac to Degas Samples .....	40
3.3 Cell Loading.....	41
3.4 Loading the Auto-Pipette.....	42
3.5 Choosing The Run Parameters .....	45
3.6 Carrying Out Experimental Runs .....	46
3.7 Using the ThermoVac for Cleaning the ITC Sample Cell.....	47
3.8 Cleaning Syringes.....	49
<b>Section 4: Experimental Tutorials</b> .....	<b>50</b>
4.1 Water-Water Baselines .....	51
4.2 Methanol Tutorial.....	60
4.3 Rnase-2'CMP Experiment Tutorial.....	63
<b>Section 5: Instrument Maintenance</b> .....	<b>64</b>
5.1 Cleaning The Cells and Pipette .....	65
5.2 Replacing Pipette Plunger Tips .....	68
5.3 Y-axis Calibration .....	72
5.4 Replacing Injection Syringes & Height Adjustment .....	74
5.5 Temperature Calibration.....	75
<b>Section 6: Tips and Troubleshooting</b> .....	<b>80</b>
6.1 User Tips and FAQs .....	81
6.2 Troubleshooting.....	82
6.3 A Note About Buffers .....	83
6.4 Selecting the Proper Stirring Rate .....	83
6.5 Estimation of Required Concentrations.....	84
<b>Section 7: Additional Features</b> .....	<b>85</b>
7.1 Extended Data Display .....	86
7.2 Customizing VPViewer.....	86

(This page was intentionally left blank)



# General

## How To Use This Manual

This manual describes the VP-ITC; its setup, operation and maintenance.

Once the instrument is setup (as described in Section 1), a new user may wish to go directly to Section 4 and run through the experimental tutorials for a “hands on” approach to learning about the instrument and software. The user should then refer back to sections 2 and 3 for detailed descriptions toward a better understanding of the intricacies of the instrument. Section 5 contains important information for maintaining the instrument performance. Section 6 provides tips for optimizing the performance and troubleshooting techniques for commonly encountered problems. Section 7 provides description of some more advanced features.

Much of this manual provides descriptions of the VP-ITC instrument and software. Bullets or step numbers are typically used when the user is requested to perform an operation.

- Indicates a step to perform an operation
1. Steps are numbered when the sequence of operations is critical.

## How to Get Help From MicroCal

The service department at MicroCal, LLC is available to help you during normal business hours, Monday through Friday from 8:00 AM to 5:00 PM (EST). Service personnel may be contacted by e-mail, phone or fax, with the preference being by phone or e-mail. When e-mailing MicroCal for technical assistance, if possible, please attach a recent data file(s) (\*.itc, raw ITC data files) that demonstrate the problem. Also, please include with the correspondence, all details that may be relevant to the problem. In instances where the problem or question relates to post run data analysis, it is best to attach the raw data file (\*.ITC) and the Origin document (\*.opj) generated during data analysis.

There are 2 general categories of problems associated with the VP-ITC and its operation. The most extreme category is when a system is simply not working, at all. **Problems that prevent users from operating the VP-ITC require immediate consultation with a MicroCal technician. Customers should not attempt to repair the VP-ITC hardware or software unless instructed to do so by a MicroCal service representative.**

The second, and less extreme general category of problems is when a VP-ITC instrument is functioning, but is not operating within its normal performance specifications. Large baseline drifting, non-repeatable control peaks (Water/Water) and/or an increase in short term noise level are all examples of performance problems, typically correctable by the operator. For performance issues such as these it is recommended that customers carry out the following minimum diagnostic steps prior to contacting MicroCal for service:

- 1.) Thoroughly clean the cells. Do not assume they are clean. As a minimum, use the provided Cell Cleaning Apparatus to pass 500 ml of a 10-25% ammoniated detergent in water solution, followed by 500 ml of cold water rinse, through the sample cell. Discretion may call for a more rigorous cleaning procedure as described herein.
- 2.) Refill both the reference and sample cells with filtered degassed water. Fill a thoroughly cleaned syringe with water and/or use a different syringe.
- 3.) Go to the *Setup/Maintenance* window within VPViewer 2000 (as described, starting on page 27) and activate the extended data mode. (While in extended data mode, ITC data files will contain all available information produced by the VP-ITC and often times is helpful in diagnosis of problems).
- 4.) Carry out a minimum of 25, 10 $\mu$ L injections of water into water
- 5.) Consult the troubleshooting section of this manual.

If, after completion of the 5 steps listed above, the ITC performance is not corrected, contact the MicroCal service department for help. The water run, in extended data mode, should be provided to the MicroCal service technician for evaluation. The service department with comments and recommendations will then contact customers.

### **MicroCal, LLC Contact Information:**

Primary Contact Phone	413-586-7720
Toll Free Phone Number	800-633-3115
Facsimile	413-586-0149
Web Site:	<a href="http://www.MicroCalorimetry.com">www.MicroCalorimetry.com</a>

Please forward corrections or suggestions concerning this manual to [info@MicroCalorimetry.com](mailto:info@MicroCalorimetry.com)

## *Symbols*

### **Symbols used in this manual**

- ! Warns the user of possible damage to the unit, draws attention to the risk of injury or contains safety notes and warnings.

### **Symbols used on the VP-ITC instrument**



Caution: Read the instruction manual before operating



Instrument (supply) ON



Instrument (supply) OFF



Protective Earth (Ground) Terminal

Origin® is a registered trademark of Origin Lab, Northampton, MA

VP™ is a registered trademark of MicroCal, LLC, Northampton, MA

MicroCal™ is a registered trademark of MicroCal, LLC, Northampton, MA

Windows™ is a registered trademark of Microsoft Corporation

## Operators Safety

- ! The points below are intended to enhance your safety awareness and to draw your attention to risks which only you, the operator, can prevent. MicroCal has set high standards for ourselves in developing and constructing the VP-ITC. Each unit constructed is fully tested to operational and safety standards. It should be noted that no amount of design or constructed safeguards can anticipate or prevent improper handling. It is intended that only responsible people trained in basic laboratory protocol in procedures and safety techniques operate this instrument. **This product is intended to operate from a power source that does not apply more than 260 V rms between the supply conductors or between either supply conductor and ground. A protective ground connection, by way of the grounding conductor in the power cord, is essential for safe operation**
- ! To avoid any hazard, use only a fuse of the correct type, voltage rating and current rating as specified on the back of the VP-ITC. This is a 1 Amp 250 Volt Time-lag (Time Delay) fuse.
- ! Repairs, alterations or modifications must only be carried out by specialist personnel. The MicroCal Service Department will be happy to serve you for any repair work or operational questions.
- ! To enhance safety always plug the instrument into a Ground Fault Circuit Interrupter (GFCI) device.
- ! A solution can become an electrical conductor when in contact with electricity and can create a hazard with the potential of burns or death. Use caution when using solutions near the instrument and adhere to the following items:
  - ! If any liquid is spilled on or around the instrument unplug the instrument immediately and wipe it up, if there is any possibility that some of the liquid may have leaked into the instrument case contact MicroCal immediately. **DO NOT PLUG THE INSTRUMENT INTO ANY POWER MAINS, until the problem is resolved.**
  - ! Do not over fill the cell and reservoir. There is a small reservoir located at the top of the access tubes to catch a minimum amount of overflow, do not exceed the capacity of the reservoir and allow any fluid to leak into the instrument cabinet.
- ! This device is not designed to the Medical Devices Directive 93/42/EEC and should not be used for medical purposes and/or in the diagnosis of patients.
- ! When using volatile or hazardous solutions in the cells, the operator should always follow proper laboratory procedures in handling (e.g. wear safety glasses and protective clothing) and disposing of such materials and allow the internal cells to cool down to room temperature before removing any solutions from the cells.
- ! All solutions in the cells must be cooled down below 50 °C before removing from the cells to prevent the glass syringes from breaking due to the hot liquids.



## Product Safety

We have used all means to design and produce the VP-ITC to prevent any damage to the instrument during normal usage. The instrument is solidly built using the latest in micro-technology in its components and design, but of course, this cannot prevent damage due to physical mistreatment. The attentiveness of the operator to the identification of materials which could corrode the Hastelloy® Alloy C-276 cells, the prevention of freezing solutions in the cells and the responsible handling and usage of the instrument should ensure a long service life for the VP-ITC.

- ! **The VP-ITC cells are constructed out of Hastelloy® C-276. Hastelloy is extremely resistant to corrosion by strong bases, but strong acids should be avoided. Please refer to the accompanying booklet “Hastelloy® Alloy C-276” for further information.**
- ! **The freezing of solutions in filled cells will cause irreparable damage to the cells due to the expansion of the solution in the cells.**
- ! **When moving the VP-ITC the instrument should always be in its normal operating or its vertical position. The instrument should never be moved in a sideways position, due to the nature of the crystal detectors used for the instruments thermal sensing, which are strong in a compression mode but weak when subjected to shear stresses.**

## Instrument Specifications

<b>Model or Type</b>	<b>: VP-ITC</b>
----------------------	-----------------

Performance Specifications	
Short Term Noise (RMS Average)	: 0.5 nanocal/sec (2 nanowatts) <sup>A</sup>
Control Peak Repeatability	: Mean ≤ 1.5μCal., s.d. ≤150 nCal <sup>B</sup>
Minimum Response Time (high gain)	: 20 seconds
Operating Temperature Range	: 2° to 80° C
Physical Specifications	
Cell Material	: Hastelloy® Alloy C-276
Dimensions (L x W x H in inches)	
Cell	: 17 x 8 x 15
Controller	: 15½ x 16½ x 7½
Monitor	: 9 x 15 x 15½
Weight (lbs)	
Cell	: 20
Controller	: 25
Monitor	: 12

<sup>A</sup> For passive mode, using 3-min time intervals and 2 second filter for data points. This noise specification depends on AC power fluctuations, and is stated here for stable AC voltage, which would be obtained using an isolated line or voltage regulator.

<sup>B</sup> Mean energy for a series of thirty, 10 μl injections of water into water or buffer into buffer run isothermally at 30°C, high gain mode, stirring at 300 rpm

## Safety Specifications

<b>Instrument Specifications (excluding Controller)</b>		
<b>Electrical Specifications</b>		
Electrical Ratings:		
Voltage	:	110 - 240 Volts
Frequency	:	50 / 60 Hz
Power	:	70 watts
Fuses (2)	:	Primary=1.0 A, 250 V, Time Delay
Output	:	Secondary/Data Connection only
Protective Earth Terminals	:	Internal/external marked
Mode of Operation	:	Continuous
Classification	:	Class I
<b>Atmospheric Specifications</b>		
Operating:		
Temperature	:	10° to 40° C
Humidity	:	0 to 75% RH noncondensing
Atmospheric Pressure	:	700 HPa to 1060 HPa
Storage: (in original shipping containers with no liquid in cells)		
Temperature	:	-40° to +70° C ( <b>no liquid in cells</b> )
Humidity	:	10% to 90%
Atmospheric Pressure	:	500 HPa to 1060 HPa

### ***Cleaning the VP-ITC Instrument Case***

Always shut down the computer controller and VP-ITC instrument and disconnect the mains power supply cord before cleaning the case. To clean the instrument case, use a damp, lint-free cloth. Avoid abrasives or solvents that can permanently damage the finish. With the damp cloth, gently wipe the external surfaces of the instrument.

## European Users: CE Mark

MicroCal VP-ITC calorimeters carry the CE marking which confirms that they meet the applicable European Community Technical Directives.

Following the provisions of the applicable European council directives:

89/336/EEC, 93/68/EEC	Electromagnetic Compatibility
73/23/EEC, 93/68/EEC	Low Voltage

Is in conformity with the following harmonized standards:

EN 61326-1:1997, A1:1998, A2:2001	Electrical equipment for measurement, control and laboratory use – EMC requirements
EN 61000-3-2:2000, A1:2001	Limits for harmonic currents emissions
EN 61000-3-3:1995	Limitation of voltage changes, fluctuations and flicker in low-voltage systems
EN 61010-1:2001, IEC 61010-1:2001	Safety requirements for electrical equipment for measurement, control and laboratory use
EN 61010-2-010:2003, IEC 61010-2-010:2003	Particular requirements for laboratory equipment for the heating of materials

## Instrument Safety Compliance

MicroCal VP-ITC calorimeters carry the CUE Safety Certification Mark, authorized by TÜV America, a division of TÜV SÜDDEUTSCHLAND, to signify that:

- 1) the instrument has been tested by an accredited Certification Body and meets applicable Canadian electrical safety standards/requirements (CSA/SCC).
- 2) the instrument has been tested by an NRTL (Nationally Recognized Testing Laboratory) and meets applicable United States electrical safety standards/requirements (ANSI/UL).
- 3) the instrument has been tested by a Competent and Notified Body for applicable EU Directives and meets applicable safety standards/requirements (EN/IEC).





# Section 1: VP-ITC System Introduction

This section starts by providing some basic information about the VP-ITC and the computer controller. Then it provides instructions for setting up the VP-ITC instrument and accessories. It ends by providing information about the ThermoVac instrument.

This section is arranged as follows:

<b>Section 1: VP-ITC System Introduction.....</b>	<b>1</b>
1.1 VP ITC – The Basics.....	2
1.2 Data Acquisition and Instrument Control.....	3
1.3 Suitable Laboratory Environment .....	4
1.4 VP-ITC Parts and Accessories .....	5
1.5 Setting Up the VP-ITC Instrument.....	7
1.6 Pipette Assembly.....	9
1.7 The ThermoVac.....	11

## 1.1 VP ITC – The Basics

The VP-ITC (Isothermal Titration Calorimeter) Unit directly measures heat evolved or absorbed in liquid samples as a result of mixing precise amounts of reactants. A spinning syringe is utilized for injecting and subsequent mixing of reactants. Spin rates are user selectable.

The normal operating range is 2°C to 80°C.

Wetted cell surfaces are Hastelloy® Alloy C 276.

Sample and reference cells are accessible for filling and cleaning through the top of the unit. The sample cell is on the right as one faces the front of the unit.

A pair of identical coin shaped cells is enclosed in an adiabatic Outer Shield (Jacket). Access stems travel from the top exterior of the instrument to the cells. Both the coin shaped cells and the access stems are totally filled with liquid during operation. This requires approximately 1.8 ml. per cell even though the working volume of the cell is only 1.4 ml

Temperature differences between the reference cell and the sample cell are measured, calibrated to power units and displayed to the user as well as saved to disk. The data channel is referred to as the DP signal, or the differential power between the reference cell and the sample cell. This signal is sometimes referred to as the “feedback” power used to maintain temperature equilibrium. Calibration of this signal is obtained electrically by administering a known quantity of power through a resistive heater element located on the cell.

The syringe containing a “ligand” is titrated (injected) into the cell containing a solution of the “macromolecule”. An injection which results in the evolution of heat (exothermic) within the sample cell causes a negative change in the DP power since the heat evolved chemically provides heat that the DP feedback is no longer required to provide. The opposite is true for endothermic reactions. Since the DP has units of power, the time integral of the peak yields a measurement of thermal energy,  $\Delta H$ . This heat is released or absorbed in direct proportion to the amount of binding that occurs. When the macromolecule in the cell becomes saturated with added ligand, the heat signal diminishes until only the background heat of dilution is observed.

With the VP-ITC system the entire experiment takes place under computer control. The user inputs the experimental parameters (temperature, number of injections, injection volumes) and the computer carries out the experiment. Origin software is then used to analyze the ITC data using fitting models to calculate reaction stoichiometry ( $n$ ), binding constant ( $K_b$ ), enthalpy ( $\Delta H$ ) and entropy ( $\Delta S$ ).

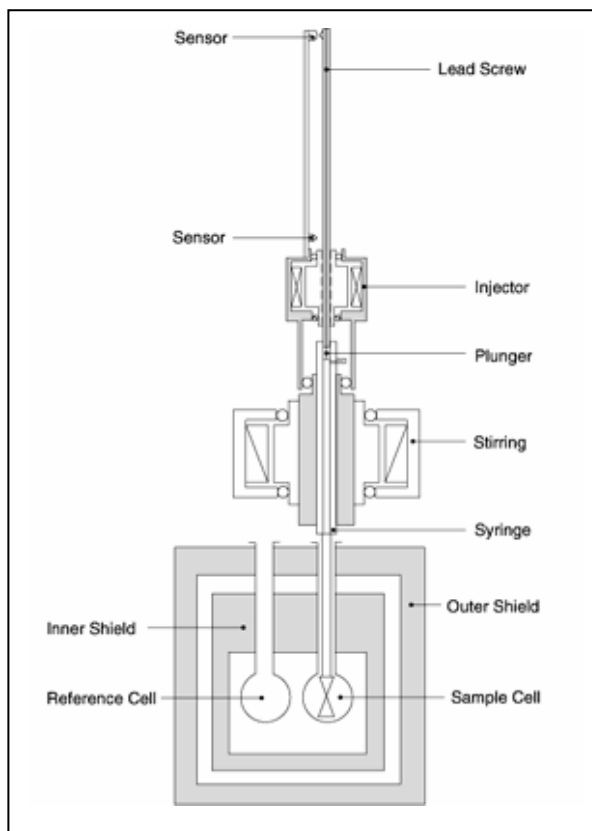

## 1.2 Data Acquisition and Instrument Control

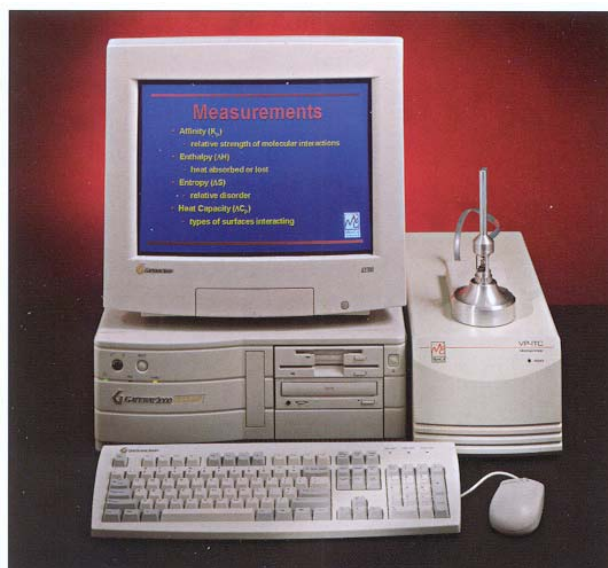

Two computer interface boards and a serial interface that reside inside the Computer Controller operate the VP-ITC. The boards are pre-configured and calibrated at MicroCal, and need no adjustments by the user.

Data acquisition is accomplished through a 16-bit A/D (analog to digital) converter board. There are five differential inputs to the A/D, consisting of the DP or differential power between the reference and sample cells, the Jacket Temperature, the DeltaT (temperature difference between the cells and the adiabatic jacket), Shield Temperature (the outer shield temperature), and the ATP channel (heat sink information). The default A/D inputs range from  $-1.25$  volts to  $+1.25$  volts for all input channels but can be changed through VPViewer. Additional available input ranges are  $\pm 2.5$  and  $\pm 5$  volts.

ITC instrument control is accomplished through the second interface board, a 16-bit D/A (digital to analog) converter board. Programmed by the VPViewer software, this board will regulate the temperature of the VP-ITC, equilibrate the ITC in preparation for a titration run, and carry out the ITC experiment.

The VP ITC injection system mounts on top of the cell unit and is controlled by VPViewer through a standard RS-232 serial interface in the Computer Controller

Although other Windows' programs can be used while the VP-ITC is running without affecting the data acquisition or calorimeter control, it should be realized that there are real time operations taking place during an experiment, and that performing CPU intensive tasks while an experiment is in progress can 'glitch' the ITC baseline. Users are encouraged to avoid large file copying to disk drives, large print jobs and recursive control loops while the VP-ITC is in the midst of an injection run. Users can carry out routine data analysis while the VP-ITC is running.

## 1.3 Suitable Laboratory Environment

The VP-ITC with Computer Controller requires about 1 meter of normal bench space (ca. 70 cm wide). The ThermoVac degassing station will require another 25 cm of bench space. This location should be away from strong drafts, room temperature fluctuations, intense sunlight, vibrations and strong electrical or magnetic fields (as may be produced by an NMR, microwave oven, large motors or refrigeration units). In addition the mains power source (110 to 240 VAC) should be properly grounded and free from voltage fluctuations, harmonic distortions, power dips and spikes.

Although, the power filtering in the VP-ITC instrument is adequate for most laboratory environments, some disturbances may affect the performance of the instrument and it may be necessary to install a power conditioner. Since power source problems can be manifested in many different ways, it is not possible to recommend a power conditioner for all situations. It is recommended that you test a power conditioner, at your location, before you purchase it. If you believe you are experiencing power source related problems, please contact a MicroCal engineer.















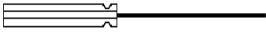
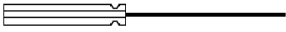

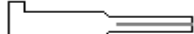

It is emphasized that room temperature fluctuations due to the cycling on/off of heating and cooling systems, strong air currents, sunlight directly on the instrument and through space electromagnetic waves may cause subtle performance problems.

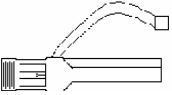

## 1.4 VP-ITC Parts and Accessories

In addition to the VP-ITC instrument, Computer Controller and connecting cables, there are various accessories shipped with the VP-ITC for its normal operation. The parts and accessories may include, but are not limited to the items listed below and on the next page. A list of the actual parts and accessories shipped with your order will be listed in the documentation included with your shipment.

Part Number	QTY	Description
ASS130010	1	VP-ITC Cell
ASS130140	1	Pipette Stand
ASS130150	1	Injector/Stirrer Base (mounted on top of ITC cell unit)
INT100010	1	Computer Controller
(call for part number)	1	Printer (optional)
SOF100040	1	VPViewer software
SOF100025	1	Origin software
ASS100030	1	Main cable
ASS130070	1	Serial Cable with two 9 pin (RS232) adapters
(call for part number)	1	A.C. Mains Power Cord
SYN161714	2	Hamilton 2.5ml filling syringes
NDL130020	1	18 guage, 8.5" long needle with Plastic syringe
ASS130090	1	Cleaning Device
ASS130120	1	Adapter (for Cleaning Device)
ASS130330	1	Shipping Cap
ASS130370	1	Temperature Standard (TC-2)
TRY100010	1	Accessory Tray
MAU130010	1	ITC Data Analysis in Origin Manual
MAU130020	1	Hastelloy Information Booklet
MAU130030	1	VP-ITC User's Manual (this manual)

VP-ITC Accessories in Wooden Box (KIT130010)			
Icon	Part Number	QTY	Description
	TIP130020	9	Plunger Tips for Injection Syringe
	ASS130360	1	250 µL Tip Sizer (Glass Bore with Green Cap)
	BRU130010	1	Large Tube brush
	ASS130170	1	Reference Plug Assembly
	DRI130010	1	Hex driver (050") for syringe clamps
	DRI130020	1	Hex driver (7/64") for injector stand
	ASS130210	1	Plastic Syringe Assembly (3cc) with tubing
	ASS130230	1	Tube holder (white) for pipette stand
	MSP13057	1	Plunger Tip Pusher tool
	MSP13056	1	Plunger Tip Puller tool
	MSP13058	1	Guide sleeve
	MSP13043	1	Threaded Cap
	FUS100010	2	Fuses (1A/250V, 5x20mm Slo-Blo Fuse)
	WIR90006	1	.013 Cleaning wire injection syringe
	ORG00005V ORG00011V ORG00016V	1	Jar WITH 10 OF EACH OF: 005 O-Ring for Cleaning Device 011 O-Ring for Adapter & Syringe Holder 016 O-Ring for Syringe Holder
	PGR130010	1	250 µl Plunger (for Cleaning Injection Syringe)
	ASS130160	1	Pipette Injector
	ASS130200	1	Syringe Holder (metal - pipette base)
	MSP13028	1	Syringe clamp for bottom of injection syringe
	SYA13022	3	Injection syringes

## 1.5 Setting Up the VP-ITC Instrument

**All VP-ITC and Computer Controller connections and setup must be done with the units turned off and unplugged to avoid damage.**

### ***Components Required for Assembly***

**Computer Controller** with CPU, Monitor, Keyboard, Mouse, Power Cord, (Printer is optional)

**VP-ITC Instrument** with flat Main Cable, Serial Cable with Adapters, Power Cord

*(Please Note: The Pipette Assembly is described in section 1.6).*

### ***Setup the Computer Controller***

- Set up the Computer Controller following the instructions that came with the computer. *It is advisable to ensure the computer is working properly before proceeding.*

### ***Connect the Flat Main Cable***

One end of the Flat Main Cable has a 37 pin male connector (labeled 'Cell') that attaches to the rear of the VP-ITC cell. The other end of the cable has two 37-pin male that attach to the rear of the computer. The connector labeled 'J1' is for the D/A (digital to analog) I/O (input-output) computer board. The connector labeled 'J2' is for the A/D (analog to digital) I/O board.

*(Note: The J2 connector cable will be slightly shorter than the J1 connector cable. Also, the 37 pin plugs are wider on one side than the other to allow the cable to fit in one direction only. If a contortion of the cable appears necessary to accommodate the appropriate connections contact MicroCal for assistance.)*

- Connect each of the two Flat Main Cable connectors (labeled J1 & J2) to their appropriate 37 pin female connector at the rear of the host Computer Controller. *(The connectors at the rear of the Computer Controller will also be labeled J1 and J2.)*
- Connect the main cable end labeled 'CELL' to the cell connector, located at the back of the VP-ITC instrument (labeled 4, on the next page).

### ***Connect the Serial Cable with Adapters***

The serial cable consists of a phone type cable with two 9 pin serial adapters; one adapter is labeled 'PC' while the other is labeled 'CELL'. The end labeled 'PC' is to be attached to the serial port (Com 1 or Com A) of the Computer Controller at J3. The end labeled 'CELL' is to be attached to the back of the VP-ITC. *(Note: Failure to connect the labeled serial connectors correctly will prevent the VP-ITC injection system from operating properly.)*

- Connect the end of the serial cable with the adapter labeled 'PC' to the Computer Controller at the connector labeled J3.
- Connect the other end of the serial cable, with the adapter labeled 'CELL' to the back of the VP-ITC (labeled 6, on the next page).

### ***Connect the Mains Power Cord***

- Connect the power cord to the inlet power receptacle located on the back of the VP-ITC. Connect the power plug only to a mains power supply receptacle with a 3 wire, protective

earth ground, plug and Ground Fault Circuit Interrupter (GFCI). *Please Note: It is strongly recommended that the VP-ITC be provided a dedicated AC power line with no other equipment being powered on that line. (see page 4 for more information about selecting a location for the instrument)*

### VP-ITC Cell Back View

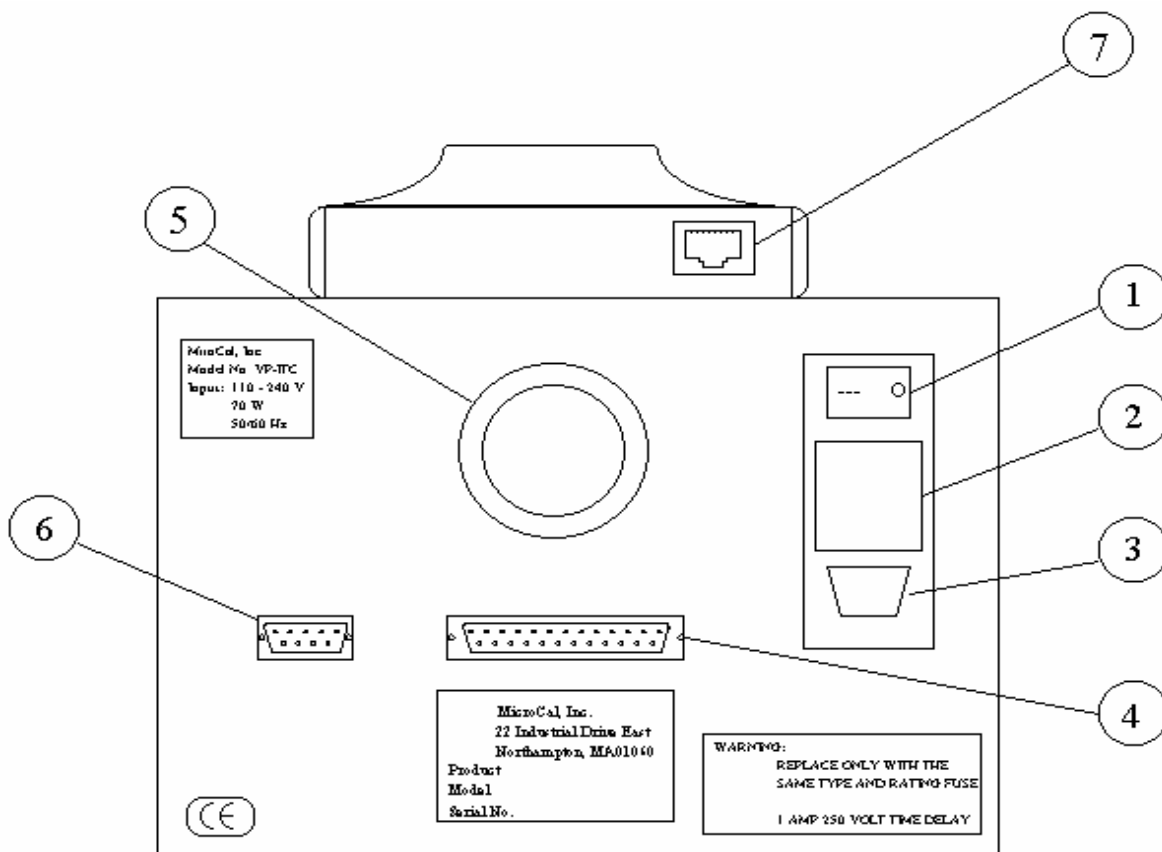

- 1) Power main switch
- 2) 2 Power fuses
- 3) IEC 320 inlet power receptacle
- 4) Cell connector
- 5) Fan
- 6) Serial Port Connector
- 7) Pipette Control Connector

## 1.6 Pipette Assembly

The pipette assembly consists of the injection syringe with pre-mounted top syringe clamp, a bottom syringe clamp, the syringe holder and the pipette injector.

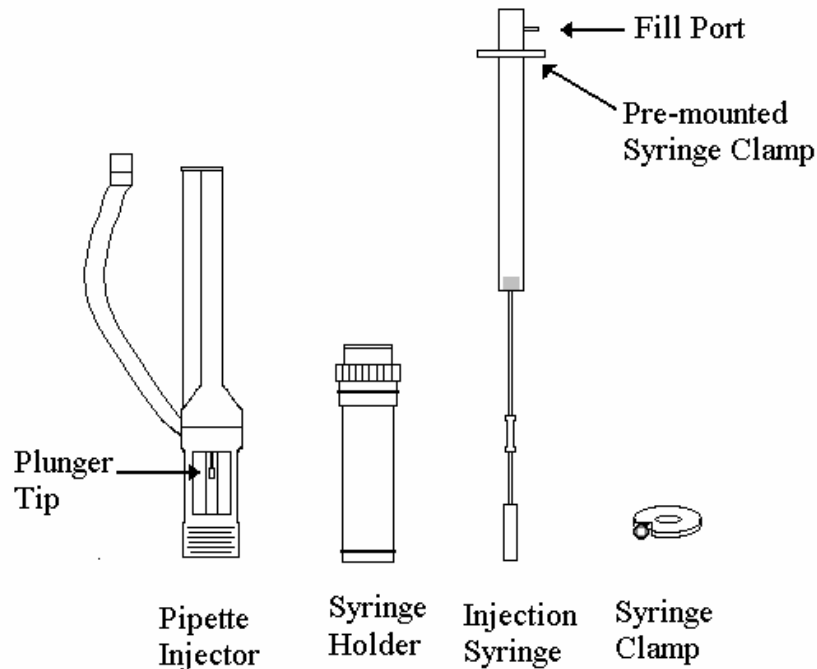

- ! **Caution:** At all times when handling the injection syringe you want to use care to prevent the long needle from any action that may cause it to bend. If the long needle is bent far enough it will become a permanent bend that will make the syringe unusable for any experiments.
- ! **Caution:** Never attempt to couple/decouple the pipette from the syringe assembly unless the pipette plunger is in the open port position (all the way up). Failure to follow this recommendation may result in a bend in the pipette screw. Even a slight bend will result in improper operation of the pipette.

To assemble the pipette, please do the following (please refer to diagrams on next page):

***The height must be adjusted for any syringe that was not part of the original shipment of your VP-ITC instrument. Please refer to Section 5.4 Replacing Injection Syringes & Height Adjustment (page 74) for instruction on adjusting the height of the syringe.***

- Insert an injection syringe into the syringe holder until the top syringe clamp is firmly seated against the top of the syringe holder. (see diagram next page)
- Insert the bottom syringe clamp over the syringe needle onto the glass part of the syringe.

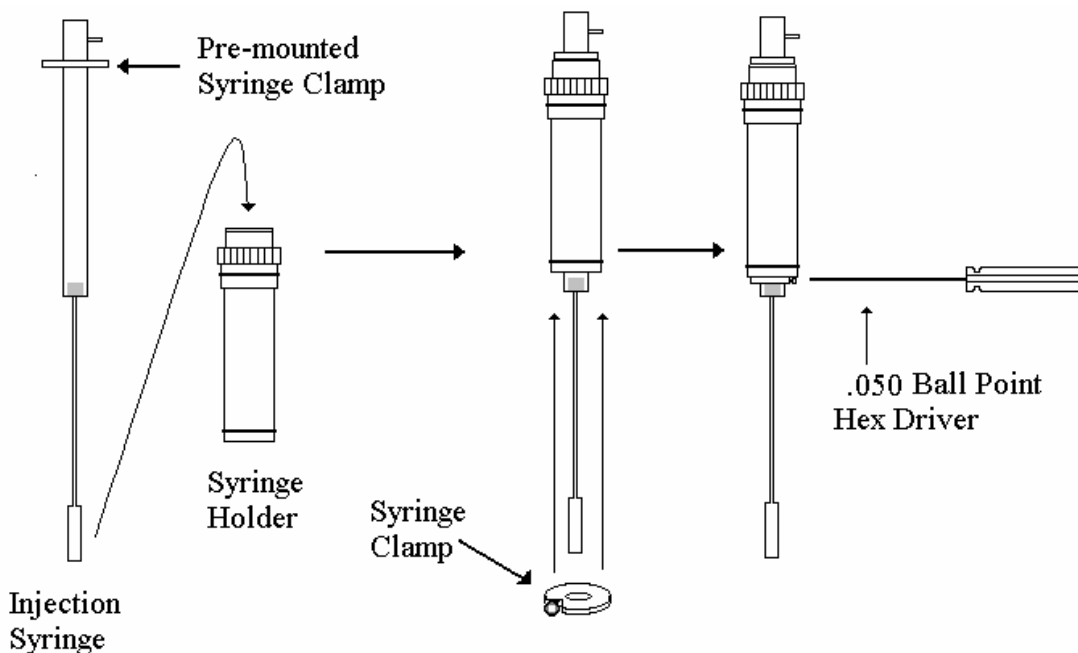

- Make sure the top syringe clamp is still seated against the top of the syringe holder, hold the bottom syringe clamp tightly against the bottom of the syringe holder and gently tighten the set screw using the accessory 0.050" Ball Point Hex Driver.

! **Use care not to over tighten the set screw, as too much pressure will cause the glass to break. You want to tighten the screw just enough to prevent the bottom syringe clamp from moving freely.**

- Insert the syringe holder into the pipette holder (attached to the side of the VP-ITC).
- Bring the pipette injector directly above the syringe holder, start bringing the injector down while observing the plunger tip of the pipette injector to insure that it is being inserted into the hole in the glass barrel of the injector syringe, then mate the screws of the pipette injector to the locking collar of the syringe holder
- With your fingers, turn the locking collar until it is fully tightened on the pipette injector.

When the locking collar is fully tightened there should be only a couple threads of the pipette injector viewable.

- Plug the connector of the pipette into the back of the pipette controller to complete the pipette assembly.

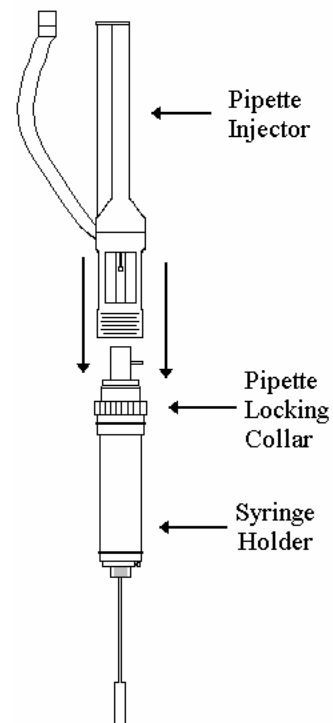

## 1.7 The ThermoVac

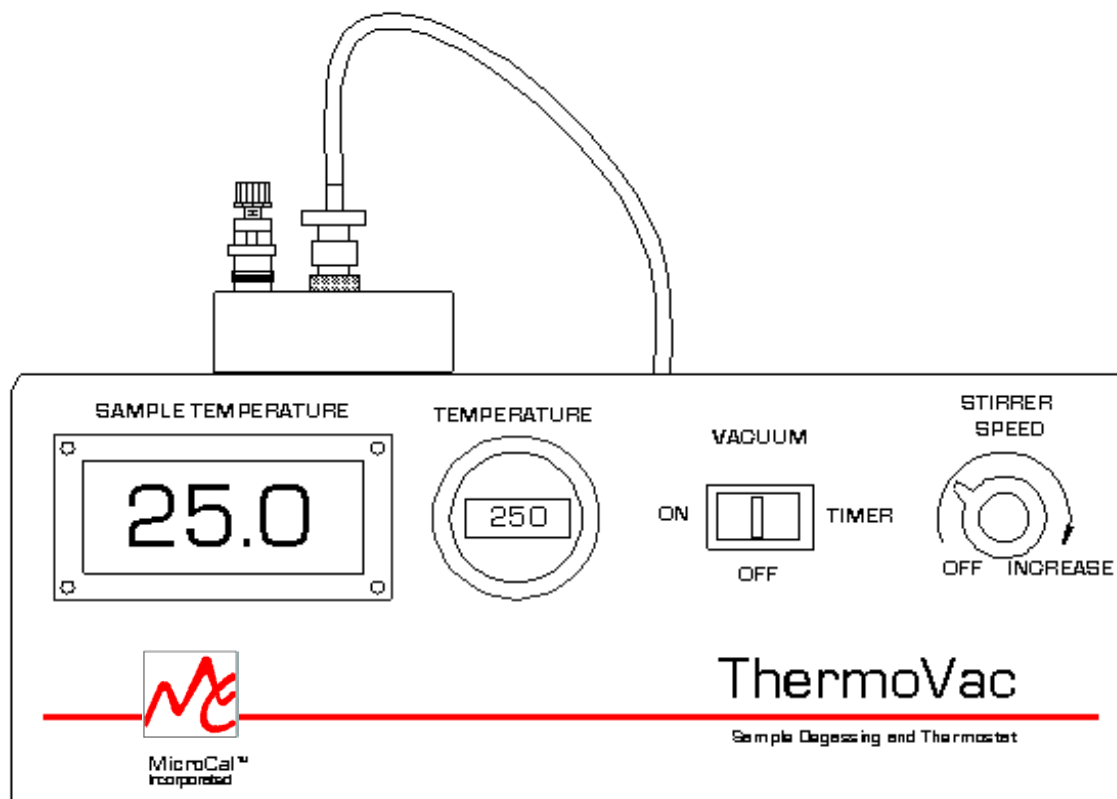

### ThermoVac Description

To facilitate degassing samples and cleaning the cells, you have been provided with the ThermoVac accessory, a device for thermostating and degassing samples. The unit is capable of thermostating a sample at any temperature from 0 to 80 °C, pulling a vacuum of 28.4 inches of mercury and stirring the sample using small magnetic stir bars.

## *ThermoVac Accessories*

The ThermoVac and accessories may include, but are not limited to the items listed below. A list of the actual items shipped with your order will be included in the documentation included with your shipment.

Quantity	Description
1	ThermoVac
3	Stir Bars (Small)
3	Stir Bars (Medium)
2	In-line filters
5	Test Tubes (Small) – for conserving sample volume
5	Test Tubes with Cap (Medium)
1	Test Tube Holder
1	Flask with Hose & Luer Lock Connector
2	Fuses (1A/250V) 5x20mm Slo-Blo
1	A.C. Mains Power Cord

## Front Panel Controls

### ***VACUUM***

The ThermoVac is capable of pulling a maximum vacuum of 28.4 inches of mercury. If the VACUUM switch is pushed to the right the vacuum pump will turn on and remain on for approximately 5 minutes (recommended time for degassing samples), then the pump will shut off. If you desire to remove the vacuum before the preset time you must turn off the main power switch (located at the rear of the instrument). When the switch is pushed to the left the vacuum pump will remain on until it is manually turned off (either by pushing the VACUUM switch to its middle, *OFF*, position or by turning off the main power switch).

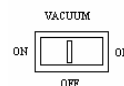

### ***TEMPERATURE***

Use this dial to set the temperature, in °C, for thermostating the sample chamber. The rightmost digit sets the temperature value in tenths of a degree. Typically, ITC samples are thermostatted to a temperature that is below the desired run temperature for the sample. This should also allow for any temperature increase that may occur during the transfer of solution from the ThermoVac to the ITC cells or syringe.

### ***SAMPLE TEMPERATURE***

Displays the current temperature of the sample chamber.



***STIRRER***

This switch will activate a rotating magnetic field that will stir your sample when a small magnetic stir bar is placed in the tube containing your sample. You may adjust the speed of the Stirrer motor from 0 RPM (OFF) to the maximum speed of 800 RPM (full turn clockwise).

***ADJUSTABLE VACUUM BLEEDER***

Allows manual adjustment of the vacuum strength within the degassing chamber of the ThermoVac.

There is no vacuum gauge on the ThermoVac, but the strength of the vacuum may need to be adjusted based on the behavior of your samples under vacuum. Depending on the specific sample being degassed, and on the temperature of the sample, the vacuum strength might be enough to boil the sample and subsequently change the concentration and/or spill the sample. This may be avoided by adjusting the strength of the vacuum with the bleeder screw. By turning the top of the bleeder screw in the counter-clockwise direction you will lower the strength of the vacuum within the ThermoVac and avoid boiling your sample. Similarly, the vacuum strength can be increased, by turning the top of the bleeder screw in the clockwise direction. The bleeder screw (and vacuum strength) can be fixed in a desirable position by tightening the lower nut, located at the base of the bleeder screw assembly, all the way in the clockwise direction.

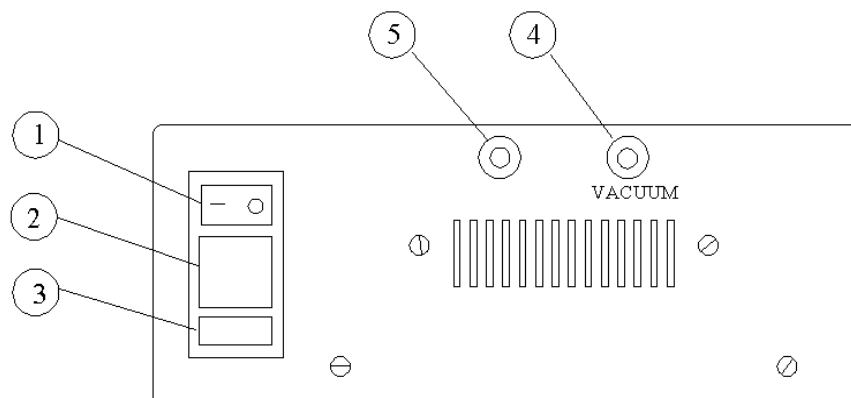
***REAR PANEL***

1. Power Main Switch
2. 2 Power Fuses
3. IEC Inlet Power Receptacle
4. Vacuum Port
5. Pressure Port

## Section 2: VPViewer and Origin Software

This section details the features of the VPViewer and Origin software. VPViewer provides the user interface to control the VP-ITC instrument and conduct the experiment. Origin (in this project window) is used only for plotting the data received from the VP-ITC instrument. A separate project window for Origin (Origin for ITC) is used for analyzing data.

New users may find this section too detailed for their immediate needs and for that reason skip this section and proceed to the Section 4 tutorials for a 'hands on' approach to learning the software through simple experiments. While performing the tutorials, the user should refer to this section when further detail is desired about a specific software function. After performing the tutorials, it is advised to read through this entire section for a thorough understanding of the software.

This section is arranged as follows:

<b>Section 2: VPViewer and Origin Software</b> .....	14
2.1 VPViewer and Origin Software Overview .....	15
2.2 Powering Up the VP-ITC Instrument .....	15
2.3 VPViewer Main Window .....	17
2.4 ITC Controls Window .....	21
2.5 Thermostat/Calibration Window .....	26
2.6 Setup/Maintenance Window .....	27
2.7 Constants Window .....	30
2.8 Real Time Data Display in Origin .....	31
2.9 ITC Cell Status .....	33

## 2.1 VPViewer and Origin Software Overview

The **VPViewer 2000** software controls the operation of the VP-ITC calorimeter. It is within VPViewer 2000 that all ITC experimental parameters are entered, runs are controlled and data is saved to the hard disk of the Computer Controller. By default, all data that is generated in the run state of an ITC experiment will be saved to disk, with no user interaction.

When VPViewer 2000 is started it opens a linked copy of a project window in **Origin**, named VPITCPlot.opj. This project window of Origin is strictly for real time display of data from VPViewer and is not intended for data analysis or saving data; VPViewer automatically saves all relevant experimental data.

*Please note:* If Origin is closed by accident, an error message will appear and the data display will be lost until Origin is again reopened by utilizing the VPViewer 2000 menu, System|Open Origin. VPViewer 2000 must be used to open up Origin for real-time display or the real-time plotting will not work. As long as VPViewer remains open, the experiment will continue and all data will still be automatically saved to disk independent of the real-time plotting.

### Operation Within a Windows™ Environment

Only one copy of VPViewer will be permitted to run at any given time. If a second instance of the application is detected, VPViewer will immediately terminate itself. Users should feel free to run Origin for data analysis simultaneously with VPViewer, as well as most other Windows' applications. In general, VPViewer is a multi-tasking application with some subtle limitations. If VPViewer detects a conflict that may jeopardize its ability to acquire data, it will inform you of this conflict. In such instances you should contact MicroCal.

Although, other Windows' programs can be used while the VP-ITC is running without affecting the data acquisition or calorimetric control it should be realized that there are real time operations taking place during a run, and that performing CPU intensive tasks while a run is in progress can 'glitch' the ITC baseline. Users should avoid large file copying to disk drives, large print jobs and recursive control loops while the VP-ITC is in the midst of a run.

## 2.2 Powering Up the VP-ITC Instrument

The VP-ITC main power switch and the VPViewer software application can be left on indefinitely. There may be occasions when the instrument is turned off and then turned back on. Problems can arise if the recommended power up sequence is not followed. Whenever powering up the VP-ITC, please follow the steps below in order:

1. Turn on the computer controller. The VP-ITC power switch must be off.
2. Once the computer controller is on and Windows is running, turn on the power switch at the rear of the VP-ITC.
3. Launch the VPViewer application by double clicking its icon on the Windows desktop or from the Windows taskbar by selecting **Start : Programs : MicroCal's VPITC : VPViewer ITC.**



*Please note:* Failure to adhere to this sequence when powering up the VP-ITC may result in the injection system not responding.

## ***A Note About ITC Power Control***

The main power for the VP-ITC cell unit is controlled by the VPViewer software application. The presence or absence of power to the cell unit is indicated by the Power LED located on the front panel of ITC cell. When the power to the cell unit is on, the LED will shine bright orange and when the power to the cell unit is off, then the LED will also be off. In order for the cell unit power to turn on, the cell must be plugged in, the power switch at the rear of the cell must be in the on position, and VPViewer must be opened and running. Upon opening the VPViewer application, it may take several seconds for the ITC cell power and the Power LED to come on. Likewise, after closing VPViewer it will require a minute or so for the cell power and Power LED to turn off.

When the VPViewer application is first opened it will go into an 'Initialization' state for less than one minute, as will be indicated in the cell status. During the 'Initialization' state the VPViewer application is disabled and will not fully respond to mouse/keyboard events. As soon as the 'Initialization' state is over with, then the VPViewer application will become fully enabled and the ITC injection system will be initialized as well.

The VP-ITC was designed to have its power on for extended periods of time. This will keep the electronics at the normal operating temperature for better repeatability. It is recommended that the power to the ITC cell unit be turned off during extended periods of down time, such as holidays and vacations.

## 2.3 VPViewer Main Window

When you launch VPViewer, the *Main Window* of VPViewer is displayed (as shown below).

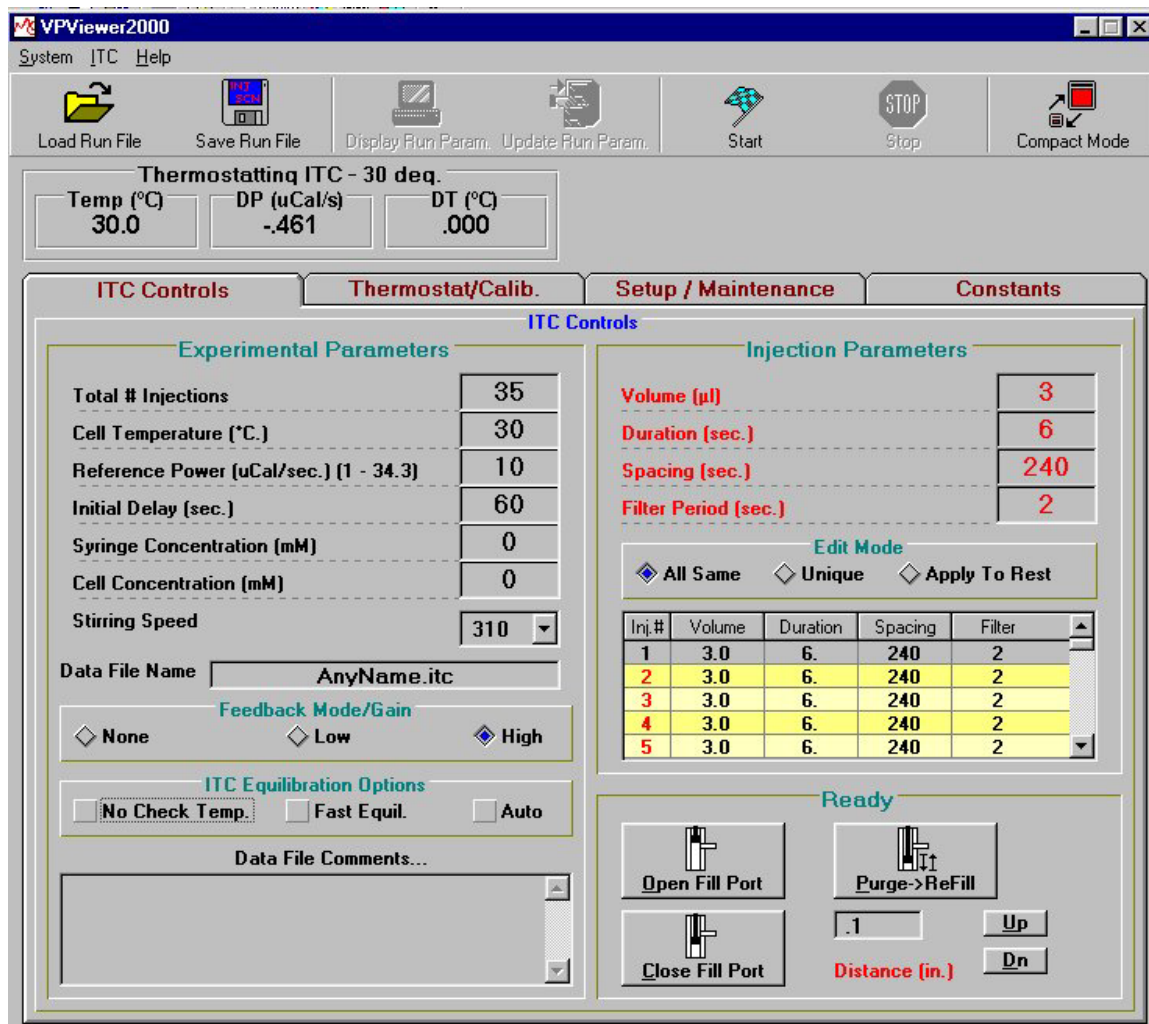

### VPViewer Data Channel Display

By default, VPViewer displays three data channels and the status of the instrument.

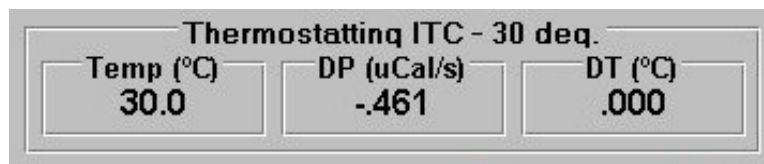

### Instrument Status

In the above illustration, the instrument is Thermostatting (ITC) at 30 °C.

### ***Temp(Celsius)***

This text box displays the current temperature, in degrees Celsius, of the adiabatic jacket.

### ***DP (uCal/sec)***

This text box displays the **Differential Power**, in  $\mu\text{Cal}/\text{sec.}$ , between the reference cell and the sample cell. Positive DP values means that the reference cell is hotter than the sample cell, while negative DP values means that the sample cell is hotter than the reference cell. In terms of reactions (assuming they take place in the sample cell) exothermic reactions will cause the DP to deflect in the negative direction while endothermic reactions will cause the DP to deflect in the positive direction. The power units for the DP data channel may be displayed in  $\text{mCal}/\text{min.}$ ,  $\mu\text{Cal}/\text{sec.}$  or  $\mu\text{Watts}$ . Experimental data will always be saved in units of  $\mu\text{Cal}/\text{sec.}$

Whenever the VP-ITC is equilibrated the DP value should be positive and stable. The power level of the equilibrated DP signal should be close ( $\pm 1 \mu\text{Cal}/\text{sec.}$ ) to the 'Reference Power' setting, as set prior to starting the run.

### ***DT (deg. C)***

This text box displays the **Differential Temperature**, in degrees Celsius, between the adiabatic jacket and the calorimeter cells (i.e. the average temperature of both cells).

Whenever the VP-ITC is equilibrated the DT signal should be close to zero degrees Celsius ( $\pm 0.05$ ) and stable.

## **Menus and Buttons**

The VPViewer Main Window contains drop down menus, buttons and Window Tabs. The *Main Drop Down Menu* selections generally control global system functions The *Main Window Buttons* allow easy access to features that are frequently used. The *Main Window Tab Selections* provide detailed windows for specific functions. The details of these controls can be found in the following sections.

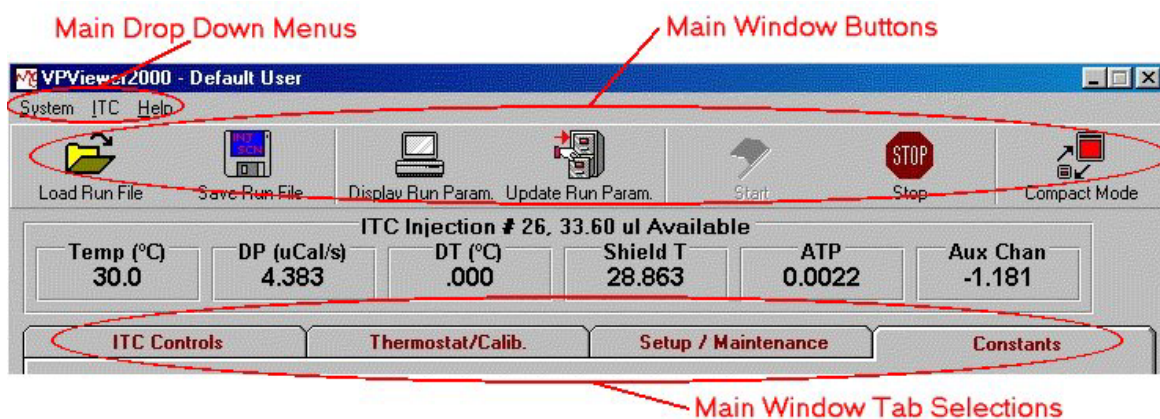

### ***VPViewer Main Drop Down Menus***

The *Main Drop Down Menus* at the top of VPViewer will provide access to some of the less frequently used functions of the application.

**System:** *Quit Program.* Selecting *Quit Program* prompts the user to see if they want to terminate the VPViewer application. Responding with *yes* will terminate the program and any run in progress. All ITC run, or partial run data will be saved to disk. Approximately a minute or so after program termination, the power to the VP-ITC will also be shut down. Power to the VP-ITC will not be restored until the VPViewer application is run again.

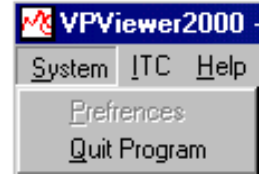

**ITC:** *Print/Save As Text Run Parameters.* This function allows users to print or save to a file the run parameters that are being used for an ITC run. While run parameters are always included as part of the ITC data file header, the *Print/Save As Text Run Parameters* menu option provides the user with a nicely formatted listing of run parameters, ideal for data presentation or general record keeping.

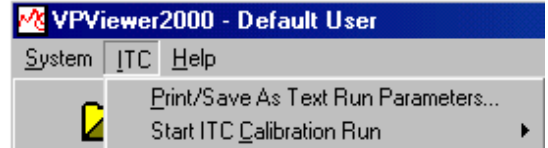

**Start ITC Calibration Run.** This option is used to check the accuracy of the ITC y-axis measurements (DP signal). Please refer to *Section 5.3 Y-axis Calibration* starting on page 72 for details on y-axis calibration.

**Help:** *Help.* Allows access to the help menus. At the time of release of this User's Manual the on-line help was still under development.

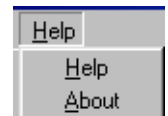

**About.** Provides specific details about this version of software and contact information for MicroCal, LLC.

## VPViewer Main Window Buttons

The Main Window buttons allow access to VPViewer's frequently used functions. The figure below shows all the buttons available for use. Depending on the current state of the instrument, some of the buttons would be grayed out and not available. (Specifically, the *Start* button is only available when the ITC is in its idle state. The *Stop*, *Update Run Param.* and *Display Run Param.* buttons are available when the VP-ITC is active, in a prerin, run or postrun state.)



**Load Run File:** Clicking on this button will display the file open dialog box to load previously saved run parameters into the ITC Controls Window. Run parameters may be loaded from one of two types of files; run parameters may be loaded from a previous experiment's data file (\*.itc), (the run parameters being extracted from the data file header) or they may be loaded from a setup file (\*.inj) which was previously saved in the *Save Run File* option (as described below).

**Save Run File.** Displays the file save dialog box which allows saving of the currently displayed run parameters. By saving the run parameters to a setup file (\*.inj) they may be reloaded and reused in the future by selecting Load Run File as described above

**Display Run Parameters.** Displays the current run parameters for the run in progress. This button is available only when the VP-ITC is in a non-idle state.

**Update Run Parameters.** Updates the current run parameters for the run in progress. When the ITC is in a non-idle state, this button must be clicked to realize the change of any run parameters. This button is available only when the VP-ITC is in a non-idle state.

Note: Only run parameters that have not yet been applied on the run in progress may be updated, all others will be ignored (e.g. after the stirring has commenced for an experiment, changes to the experimental stir speed will be ignored).

**Start.** Click this button to start an ITC experiment, using the parameters entered into the ITC Controls Window.

**Stop.** This button terminates the current run. Available only when the VP-ITC is in a non-idle state.

**Compact/Standard Mode Button**



Clicking this button will shrink VPViewer's *Main Window* and change the icon to the Compact Mode (as shown below). *VPViewer's Main Window* size cannot be manually adjusted. It has only 2 sizes, the compact mode size and the standard size. Clicking on the **Standard Mode** button will restore the window to its original size.

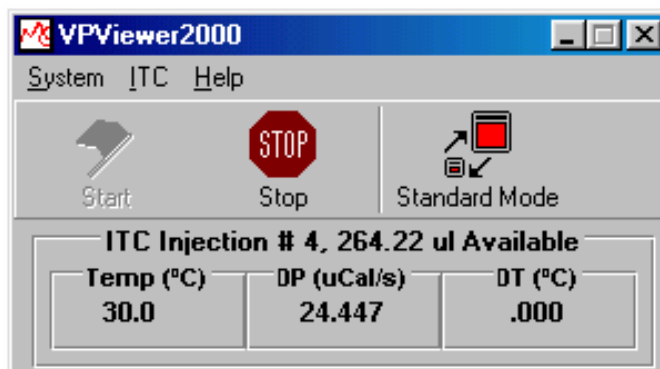



## 2.4 ITC Controls Window

The ITC Controls window (shown below) is the main access point for operating the VP-ITC instrument.

The ITC Controls window is divided into several sections:

- Experimental Parameters:**
  - Total # Injections: 65
  - Cell Temperature (°C.): 30
  - Reference Power (uCal/sec.) (1 - 34.3): 5
  - Initial Delay (sec.): 60
  - Syringe Concentration (mM): 0
  - Cell Concentration (mM): 0
  - Stirring Speed: 300
  - Data File Name: default.itc
  - Feedback Mode/Gain:  None,  Low,  High
  - ITC Equilibration Options:  No Check Temp.,  Fast Equil.,  Auto
  - Data File Comments...
- Injection Parameters:**
  - Volume (μl): 5
  - Duration (sec.): 5
  - Spacing (sec.): 120
  - Filter Period (sec.): 2
  - Edit Mode:  All Same,  Unique,  Apply To Rest
  - Table:
- Ready:**
  - Open Fill Port
  - Purge->ReFill
  - Close Fill Port
  - Distance (in.): .1
  - Up, Dn buttons

In...	Volume	Duration	Spacing	Filter
1	5.0	5.0	120	2
2	5.0	5.0	120	2
3	5.0	5.0	120	2
4	5.0	5.0	120	2

Below is a description for each of the run parameters displayed in the ITC Controls window.

### *Experimental Parameters*

#### *Total # Injections*

Enter the total number of injections (500 is the maximum) for the titration (ITC) experiment.

#### *Cell Temperature (° C)*

Enter the desired temperature for the experiment.

If there is a check mark next to the **No Check Temp.** option in the **ITC Equilibration Options** group (see below), the entered temperature will be ignored and the experimental temperature will take place at the current cell temperature. If there is no check mark, then the cell will scan to the entered temperature and equilibrate before the experiment will start. *Please Note: When the instrument is programmed to scan to a new temperature (i.e. there is not a check mark next to the **No Check Temp.** option), the sample should be cooled (before loading into the cell) below the experimental temperature, so that after loading, the temperature of the sample in the cell will be*

*at or below the experimental temperature. If the loaded sample is at a higher temperature, there will be a long equilibration period before the experiment will begin. (See page 82 more information).*

### ***Reference Power ( $\mu\text{Cal}/\text{sec.}$ )***

Throughout an ITC experiment, a small constant amount of power (equal to the value entered here) is continuously supplied to the offset heater of the reference cell. This causes the DP feedback system to become positive to supply compensating power to the sample cell that will equilibrate the temperatures. During an experiment the DP baseline will equilibrate near the value entered in this box. The reference power setting is often referred to as the baseline setting.

The best choice for the reference power setting will be determined by the anticipated size and direction of the titration peaks. Large exotherms will require a large reference power setting (ca. 30  $\mu\text{Cal}/\text{sec.}$ ) and large endotherms will require a very small reference power setting (ca. 2  $\mu\text{Cal}/\text{sec.}$ ).

### ***Initial Delay (sec.)***

Enter the time, in seconds, from the start of the experimental data collection until the time of the first injection. The minimum time allowed by VPViewer for this parameter is 60 seconds; this is necessary to establish a baseline prior to the first injection.

### ***Syringe Concentration (mM)***

Enter the mM concentration of the solution in the syringe.

This value is stored in the data file header and used in Origin for ITC data analysis. This value is used only during data analysis and an entry is not required to perform an experiment. If the value is not entered or entered incorrectly the user will be warned, but it can also be entered/edited in data analysis.

### ***Cell Concentration (mM)***

Enter the mM concentration of the solution in the cell.

This value is stored in the data file header and used in Origin for ITC data analysis. This value is used only during data analysis and an entry is not required to perform an experiment. If the value is not entered or entered incorrectly the user will be warned, but it can also be entered/edited in data analysis.

### ***Stirring Speed***

Select the desired stirring rate from the drop down list (310 is recommended for most ITC experiments).

There are 5 stirring rates available, they are ca. 0, 270, 310, 500 and 580 RPM (revolutions per minute). The exact stir rate for your instrument is measured and the value is entered into the software. The default rate of ca. 310 RPM has been found to be desirable for most experiments. If the solution in the sample cell contains suspended particles (e.g. agarose beads), faster stirring will be necessary. *Please refer to the section **Selecting the Proper Stirring Rate** starting on page 83, for more information.*

### **Data File Name**

Following Windows filename requirements enter up to 16 characters for the filename. The program will automatically add .ITC for an extension name, so that the raw data file will be recognized by Origin as a VP-ITC data file. Do not start the filename with a number nor include any hyphens, periods or spaces in the filename, as Origin will not accept the file. *Please note: Origin for ITC data analysis can only distinguish a difference in file names for the first 10 characters, therefore if you will be analyzing more than one data file in a single session of Origin make sure that each file name has a unique combination of characters within the first 10.*

### **Feedback Mode/Gain**

Select one of the three available modes, None, Low or High (High is recommended for most ITC experiments).

The feedback modes can be described as active (Low or High) or passive (None). High gain will provide the fastest response time, while passive mode (None) will provide the highest sensitivity (slowest response time). Most ITC reactions will require using the High gain feedback mode, which yields the fastest response time. Monitoring of long, slow thermal process in the VP-ITC (i.e. kinetics, metabolic rates) might benefit from using the passive or low gain feedback modes.

### **ITC Equilibration Options**

This group of check boxes determines how VP-ITC will equilibrate before collecting data for the experiment. To start an experiment in the shortest possible time put a check mark in each box.

**No Check Temp.** – When this check box is selected the **Cell Temperature (°C)** text box entry will be ignored and the experiment will start at the current cell temperature. Otherwise the cell will equilibrate at the temperature entered into the **Cell Temperature (°C)** text box before the experiment can start. *Please Note: When there is not a check mark next to the **No Check Temp.** option, the cell sample should be cooled (before loading) far enough below the experimental temperature, so that after loading, the temperature of the sample will be at or below the experimental temperature. If the loaded cell sample is at a higher temperature, there will be a long equilibration period before the experiment will begin. (See page 82 for more information).*

**Fast Equil.** – When this check box is selected, VPViewer will not establish a non-stirring equilibration period. This will allow for slightly faster equilibrations and in general is the best way to run the ITC. There may be instances where the operator would like to view a non-stirring baseline and can do so by removing the check mark next to this option.

**Auto** – When this check box is selected the ITC experiment will proceed through the equilibration states (Pre-stirring and Final Baseline) and complete the experiment without any further interaction from the user. Users can still force an equilibration state to the next equilibration state by double clicking on the DP data box (just as is done with the auto-start option inactive).

### **Data File Comments**

You may type into this text box comments about your experiment to be saved in the header of the data file for future reference.

## ***Injection Parameters***

The Injection Parameters group allows you to define the *volume*, *duration*, *spacing* between injections, and the *filter* period for each injection. At the bottom of this group is a summary table that lists, by row number, these parameters. You may select an injection to edit by clicking on a row to highlight it; the parameters for this injection will be entered into the text boxes. Then, depending on the **Edit Mode** selected, you may edit the text boxes to effect all injections (**All Same**), only the currently highlighted injection (**Unique**) or the currently highlighted injection and all the following injections (**Apply To Rest**).

### ***Volume ( $\mu$ l)***

Enter the volume of titrant (in micro liters), to be injected from the pipette into the sample cell for the selected injection(s).

### ***Duration (sec.)***

Enter the time, in seconds, for the titrant to be injected into the sample cell for the selected injection(s).

*Note:* VPViewer will default this value to be twice the number entered in the Volume text box.

### ***Spacing (sec.)***

Enter the time, in seconds, between the beginning of the selected injection(s) and the beginning of the next injection.

The user is responsible for specifying enough time between the injections to allow the DT signal to return to the baseline after an injection peak deflection. Typical values for this parameter range from 180-300 seconds, depending on the size of the peak and the kinetics of the reaction.

### ***Filter Period (sec.)***

This is the time period (in seconds) in which the data channel conversions are averaged to produce a single data point for plotting and saving.

For fast reactions, a filter period of 2 seconds is sufficient to obtain enough data points for representation of the peak for accurate integration of the area. For monitoring of very long, slow thermal processes, the filter period may be increased accordingly to avoid accumulation of excess data points. *Please note:* Although there may be a practical limit for a data set size, only available disk space would limit the number of data points that VPViewer is able to collect and save.

## ***Edit Mode***

**All Same** – Selecting this option causes all injections to be assigned the same parameter values as entered into the **Injection Parameter** text boxes.

**Unique** – This option allows you to set up injections using different parameters. You may customize each injection to have different volumes, duration, spacing or filter periods. Editing the **Injection Parameter** text boxes when this option is selected effects only the injection that is currently highlighted in the summary table. Likewise the values displayed in the individual parameter boxes apply only to the injection that is currently highlighted in the summary table.

**Apply To Rest** – Selecting this option, you will be assigning the injection parameters for the currently highlighted injection (in the summary table), to all ensuing injections. Likewise, editing an injection parameter while this option is selected affects the currently highlighted injection (in the summary table), as well as all ensuing injections.

## ***Pipette Controls***

This group of buttons control the injector movements of the pipette. The group box is labeled **Ready** when pipette controls are enabled or **Busy** when a movement is currently being made. The end of a movement is signaled by a beep and the group label, switching from **Busy** to **Ready**

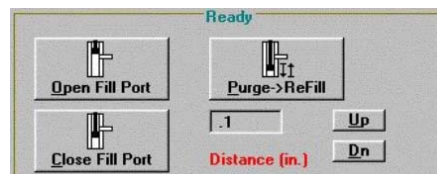

### ***Open Fill Port***

This button is used for positioning the plunger tip for loading the pipette with your sample. When you click on this button the injector screw of the pipette plunger will retract until the plunger tip is positioned just above the fill port of the injection syringe. This will allow you to attach the hose of the plastic syringe to the fill port for filling the pipette injection syringe with your sample.

### ***Close Fill Port***

This button is for positioning the plunger below the fill port after filling the pipette with your sample. When you click on the button the injector screw will extend so the plunger tip is just below the filling port of the injection syringe. This should be done immediately after filling the pipette syringe and before removing the hose of the filling syringe.

### ***Purge->Refill***

This button will completely extend the plunger tip of the pipette injector to inject the sample back into the filling test tube, and then raise the plunger to refill the injection syringe. When the movement is complete the plunger tip of the injection syringe will be positioned to its original position, just below the filling port. A beep will indicate the start of the movement a second beep will indicate completion of the movement.

The purpose of the purge/refill procedures is to dislodge any air bubbles from inside walls of the injection syringe (which may have occurred during the first filling) and expel them back into the titrant solution. It is recommended to perform this procedure twice, after loading the pipette before an experiment.

### ***Distance (in.)***

You may move the injector a set distance, either up or down, by entering the distance to be moved (in inches) in the text box and clicking either the Up or Dn (Down) button.

## 2.5 Thermostat/Calibration Window

The Thermostat/Calibration Window allows access to the thermostat control and DP calibration pulse function.

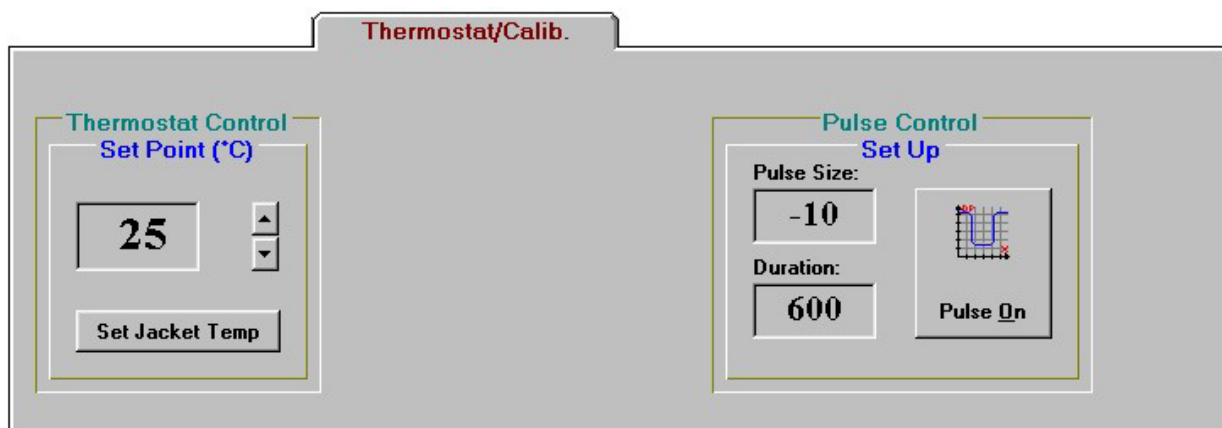

### *Thermostat Control*

Thermostat Control allows for setting of the thermostat temperature, which will be maintained during the VP-ITC Thermostating state. Pre-thermostating the VP-ITC and samples will result in shorter equilibration times. Additionally, high temperature thermostating during cell cleaning can improve the effects of the cleaning.

### *Pulse Control*

Allows for manually administering a DP calibration pulse. While this is not the most thorough method of checking the y-axis calibration, it is the quickest and most convenient method. Pulses may be applied any time the DP signal is equilibrated and the resulting deflection used as a crude calibration assessment. Using a pulse which is relatively large ( $> \pm 5$  mCal/min.) will expose DP calibration errors that are greater than 1%. Any users who feel that the y-axis calibration requires adjustment should contact MicroCal prior to attempting any changes to the VP-ITC calibration constants.



## 2.6 Setup/Maintenance Window

The *Setup/Maintenance* window allows access to change user preferences for the default settings of run parameters. Systems having multiple users may benefit from having customized settings.

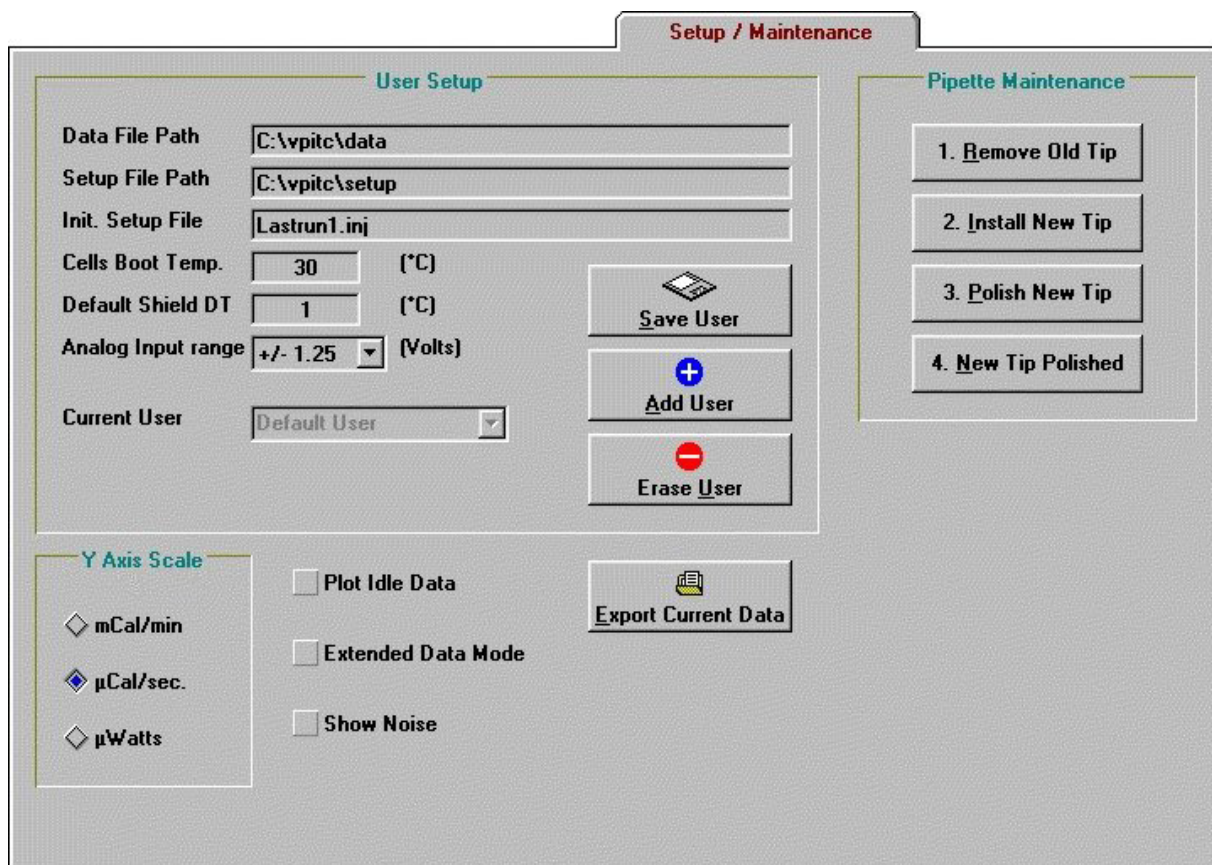

### User Setup

**Data File Path:** Indicates the path (excluding file name) where VP-ITC data files will be saved. The path should be located on a local hard drive and not on any floppy or CD-ROM drive. This setting may only be changed while the VP-ITC is in the idle state, Thermostating. To change the current data file path, double click on the existing path text and a dialog box will open allowing you to change the path. The desired data directory must already exist in order to select it from the dialog box. **Note: In order to be read into Origin for data analysis the path cannot contain any spaces.**

**Setup File Path:** Indicates the path (excluding file name) where VP-ITC setup files will be saved and loaded. The specified path should be located on a local hard drive and not on any floppy or CD-ROM drives. To change the current setup file path, double click on the existing path text and a dialog box will open allowing you to change the path. The desired setup directory must already exist in order to select it from the dialog box.

**Init. Setup File:** Specifies the initial setup file, which will be loaded into the experimental control window, the first time it is opened. Specifying the initial setup file as LastRun1.inj will result in the last run parameters that were executed to be loaded at startup.

**Cells Boot Temperature:** Upon launching VPViewer, the ITC will scan to, and then thermostat at, the temperature entered into this text box.

**Default Shield DT:** The default temperature difference between the ITC adiabatic jacket and the outer shield of the VP-ITC. The default setting of a 1 degree difference has been found to be ideal for all ITC applications and should not be changed without consultation with a MicroCal engineer.

**Analog Input Range:** Determines the maximum range of measurable DC voltages for all VP-ITC data channels. The default range of +/- 1.25 volts is adequate for almost all ITC applications and provides for the greatest sensitivity. In instances where heats are too large to be measured using the default setting, increasing the Analog Input Range can increase the range of DP measurement. Please consult a MicroCal engineer prior to making this change.

**Save/Add/Eraser User:** These buttons provide a convenient way of maintaining unique startup parameters and placing data files in different folders for multiple users. (See section 7.2 *Customizing VPViewer*, starting on page 86, for more information)

### Y-Axis Scale

The Y-axis group allows for changing of the current y-axis (DP) units. Available y-axis units are mCal/min.,  $\mu$ Cal/sec. and  $\mu$ Watts. By default, y-axis units will be displayed in  $\mu$ Cal/sec. Changing y-axis units will only change the power units for 'local' data displayed in real-time, within VPViewer and Origin. All data files will be saved with the default units of  $\mu$ Cal/sec

### Diagnostics

This group is used for diagnostics and troubleshooting and would normally not be utilized unless instructed by a MicroCal engineer.

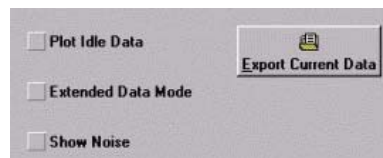

**Export Current Data:** Users may be instructed by a MicroCal engineer to click the *Export Current Data* button. This provides service personnel with a convenient means of capturing ITC data, which otherwise is not saved to disk.

**Plot Idle Data:** Users may be instructed by a MicroCal engineer to checkmark the *Plot Idle Data*, for use in troubleshooting. This provides service personnel with a convenient means of capturing ITC data, which otherwise is not saved to disk.

**Extended Data Mode:** This mode of operation will save all data the VP instrument produces to the data file. This provides MicroCal engineers with extra data for troubleshooting.

**Show Noise:** When this box is checked the Real-Time Noise group box will be displayed. From this group you may elect to numerically display the RMS (Root-Mean-Squared) or PTP (Peak-To-Peak) noise.

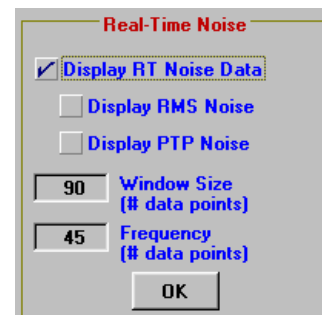



## ***Pipette Maintenance***

This group of buttons provides controls for replacing plunger tips. It is recommended to replace tips once a month when using the VP-ITC daily. (For more information refer to the section on Replacing Pipette Plunger Tips starting on page 68).

***Remove Old Tip*** – Click this button to position the injector plunger screw in a retracted position, so that the accessory tools may be used to remove the old plunger tip.

***Install New Tip*** – Click this button to position the injector plunger (in a retracted position) so that the Tip Pusher Tool may be used to insert a new plunger tip on to the end of the plunger screw.

***Polish New Tip*** – After installing a new tip, clicking this button will position the injector plunger tip (in an extended position) so that the glass polishing tool may be used to polish the plunger for first time use.

***New Tip Polished*** – After polishing a new tip click this button to the plunger screw, this will position the screw properly for putting the pipette back together.



## 2.7 Constants Window

Provides viewing access to the calibration constants for your particular VP-ITC instrument. Shown below are calibration constants that are typical of the VP-ITC. This window is password protected and should not be changed without instructions by a MicroCal Engineer.

Constants

VPITC08.00.162

Cell Parameters		I/O Channel Coefficients	
Cell Volume	1.4301 ml	Jacket T Read	Slope: 99.679441    Offset: -.63493
Ref. Cal. Htr.	121.55 Ohms	DeltaT Read	.2232
Samp. Cal. Htr.	120.55 Ohms	Shield T Read	99.077126    -.22786
Min. Safe Temp.	1 °C.	ATP Read	8    0
Max. Safe Temp.	80 °C.	<b>DP FB Mode</b>	<b>A/D Slope    D/A Slope</b>
		DP Pasive FB	10.834    0
		DP Low Gn FB	14.4778    2
		DP Mid Gn FB	29.044    4.472
		DP High Gn FB	32.71076    7
		T2 Set Point	Slope: .053319    Offset: .02016
		ATP Output	0    18

ITC Injector Coefficients	
Steps Per Inch	6096
Max. Safe Position	18790 steps
Syringe Constant	101.8 ul/in.
260 RPM 1	310 RPM 2
490 RPM 3	560 RPM 4

Calibrate

Save

UnLock Constants

## 2.8 Real Time Data Display in Origin

### *Data Display Project Window Overview (VPITCPLOT.OPJ)*

When VPViewer is opened, it will open the Origin™ project window **VPITCPLOT.OPJ**. **VPITCPLOT.OPJ** has been customized for real time data display. This project of Origin is dedicated for data display only, and should not be used for data analysis. Users should open a separate copy of *Origin for ITC*, to perform data analysis.

This section is intended to detail those features that are contained in the **VPITCPLOT.OPJ** data display project of Origin. Please refer to the *Origin User Manual* for a complete description of Origin. For details on ITC data analysis, refer to the *ITC Data Analysis in Origin Tutorial Guide*.

Pictured below is the main Origin window for VP-ITC data display.

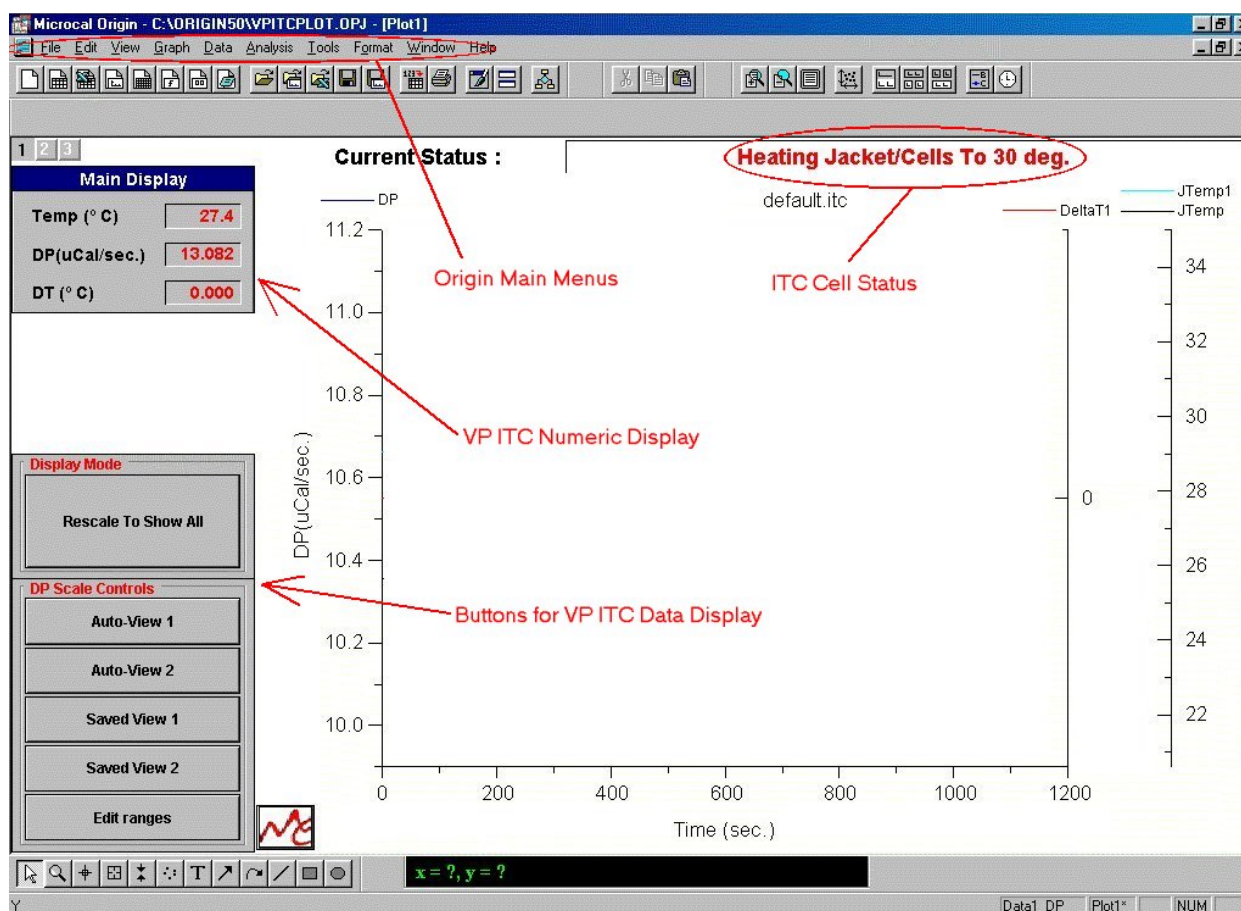

The *ITC Cell Status*, the *VP-ITC Numeric Display* and the *Buttons For VP-ITC Data* tools (as indicated above) have been added for user convenience in viewing data generated by the VP-ITC. Following is a description of each of these sets of tools.

## Buttons for VP-ITC Data Display

This group of buttons allows you to rescale the y-axis by simply clicking on a single button. Alternatively, you may graph all the data by selecting **Plot:Rescale to Show All** from the Main Display menu or you may rescale either the x or y axis by double-clicking on the axis and manually entering the new scale in the opened Axis dialog box (see the *Origin User's Manual* for more information)

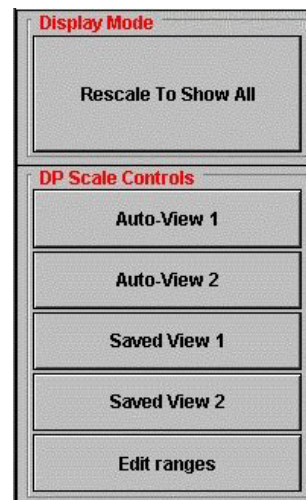

### Display Mode

**Rescale To Show All** – Clicking this button, rescales the x and y axis ranges so that all data will be displayed on the graph.

### DP Scale Controls

**Auto-View 1** – When you click on this button, the y-axis will be rescaled so that the last data DP data point plotted will be centered on a full scale determined by the entry in the **Full Scale-Auto View 1** text box (see *Edit Range* description below). *Please note: For the Auto-View 1 (& 2) buttons to work properly, there must be data plotted in the Main Display graph.*

**Auto-View 2** – This button provides a second range for rescaling the y-axis centered on the last DP data point plotted (determined by the entry in the **Full Scale-Auto View 2** text box (see *Edit ranges* below)).

**Saved View 1** - When you click on this button the y-axis will be scaled from the value entered in the **Saved View 1-Y Min.** text box to the value in the **Saved View 1-Y Max.** text box. (see *Edit Range* description below).

**Saved View 2** – When you click on this button the y-axis will be scaled from the value entered in the **Saved View 2-Y Min.** text box to the value in the **Saved View 2-Y Max.** text box. (see *Edit Range* description below).

**Edit Ranges:** Opens a window that contains parameters to be used with the aforementioned buttons. In addition to the *Auto-View* and *Saved-View* entries, which are described above, there is a drop down list box that will control the automatic re-scaling of the x-axis. The drop down list is labeled as *X Axis Options* and contains three choices, as defined below

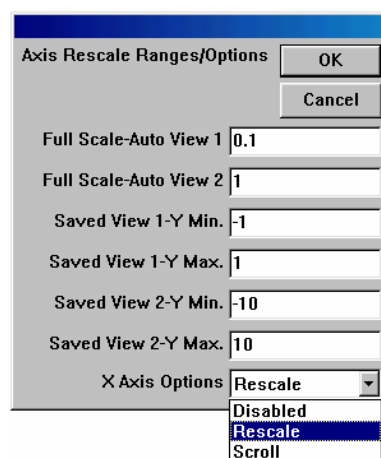

**X Axis Options** – Determines the action taken by VPViewer when the current time data extends beyond the X Axis display range.

**Disabled:** Takes no action. Current data may be plotted off screen.

**Rescale:** Extends the maximum X Axis setting by 25%, resulting in a larger display range.

**Scroll:** Extends the minimum and maximum X Axis setting by 25%, preserving the same range of the display, but always displaying the most recently plotted data.

Click **OK** to exit and save any changes or **Cancel** to exit without saving any changes.

## ***VP-ITC Numeric Display***

This group of display text boxes shows the same data channels as VPViewer, as described in section 2.3 *VPViewer Main Window*.

## **2.9 ITC Cell Status**

### ***States of Operation***

The VP-ITC is a 'state driven' instrument. The current state of the ITC (cell status) is displayed in both VPViewer and Origin. There are six unique states that comprise an ITC run, thermostating (idle), Seeking Temperature, PreRun Thermostat, Prestirring Equilibration, Final Baseline Equilibration and Running. A description of each of these six states can be found below.

#### ***Thermostating (idle state)***

When the VP-ITC is not equilibrating or performing a titration run, it sits in an idle state, the *Thermostating State*. While in the thermostating state, the only function for the VP-ITC is to achieve and maintain the currently defined thermostat temperature. The VP-ITC will remain in its idle state until the operator starts a run. Access to the current thermostat temperature is obtained through the *Thermostat/Calib*. Main Window tab.

#### ***Seeking Temperature (Heating/Cooling Jacket/Cells to Set Temperature)***

The function of this first prerun state is to heat or cool the VP-ITC cells and adiabatic jacket to the entered starting temperature for the experimental run. This is accomplished when the cell temperature is within 0.1 degrees (of the entered temperature), and the DeltaT (temperature difference between cells and adiabatic jacket) is less than 0.001 Deg. To save equilibration time it is usually best to set the VP-ITC thermostat temperature to be the same as the starting temperature of the ensuing run, or colder.

When filling the cells with solution prior to a run, the sample being loaded should always be colder than the desired experimental temperature, in order to minimize the amount of time required to equilibrate the ITC. Loading solution that is hotter than the desired run temperature will cause for lengthy equilibrations and/or a run temperature that is slightly higher than requested.

When the VP-ITC requires cooling to achieve the requested starting (or thermostat) temperature, it uses a different algorithm than when it requires heating. Since there is no active cooling of the cells or jacket, the outer shield will be used to 'pull' the jacket and cells lower in temperature through conduction and convection inside the ITC. To increase the rate of cooling, the outer shield will be cooled well below (10 degrees below) the requested target temperature, causing the jacket to go well below the target temperature. Although the jacket and outer shield will be well below the target temperature, the cells will take longer to cool and the algorithm will wait for the cells to be below the target temperature. Once the jacket and cells are below the target temperature they will be heated up to the requested target temperature.

### ***PreRun Thermostat***

Once the cells and jacket have reached the starting temperature, the ITC will enter the 2<sup>nd</sup> prerun state, the *PreRun Thermostat* state. The purpose of the PreRun Thermostat state is to maintain the starting temperature, for the requested period of time. This will allow time for thermal gradients within the ITC cell thermal core to minimize before the experiment starts to reduce their effect during the experiment. The duration of the PreRun Thermostat state is 5 minutes.

### ***PreStirring Equilibration***

After the pre-run thermostat period has elapsed, VPViewer and the ITC cell will enter PreStirring equilibration. During this state the instrument will establish a zero degree DeltaT (temperature difference between the jacket and the cells) to establish adiabatic conditions suitable for sensitive thermal measurements. The DP signal will stabilize at a power level that is close (i.e within 1  $\mu$ cal/sec) to the 'Reference Power' setting.

### ***Final Baseline Equilibration***

After the PreStirring Equilibration has been reached, the VP ITC instrument will enter the Final Baseline Equilibration or the stirring state. The VP will start rotating the syringe. The start of the stirring will cause the DP signal will deflect downward, then the signal will increase, but stabilize at a level slightly lower than the non-stirring baseline. The instrument will stir continuously for the remaining portion of the run.

### ***Running***

Once the DP signal has stabilized after the start of the stirring, the instrument will enter the run state. The run commences with an initial delay to provide baseline data prior to the first injection. Then the injections will be executed according to the injection schedule.

The instrument responds to an exothermic reaction by decreasing the feed back heat provided to the sample cell. That is, heat added to the sample cell by an exothermic reaction will result in a downward deflection in the baseline DP signal. This downward deflection is proportional to the energy not needed to maintain the temperature equilibrium between the sample and reference cells. The integrated area of this deflection is referenced to the baseline before the injection and after the reaction has completed. An endothermic reaction will require more heat in the feed back loop to maintain the same temperature resulting in a positive deflection.

## ***Origin Main Menus***

A description of the features of these menu items may be found in the Origin User's Manuals. These features are generally not utilized during data collection.

## Section 3: Running an ITC Experiment

This section provides detailed information about conducting an experiment, from designing, sample preparation, loading samples, running the experiment and finally cleaning the equipment after the experiment. New users may find this section too detailed for their immediate needs and may proceed to the Section 4 tutorials for a ‘hands on’ approach to learning the instrument through simple experiments. While performing the tutorials, the user may refer to this section if further detail is desired about a specific operation. After performing the tutorials, it is advised to read through this entire section for a thorough understanding of running an ITC experiment.

This section is arranged as follows:

<b>Section 3: Running an ITC Experiment</b> .....	<b>35</b>
3.1 Designing ITC Experiments .....	36
3.2 Using the ThermoVac to Degas Samples .....	40
3.3 Cell Loading .....	41
3.4 Loading the Auto-Pipette.....	42
3.5 Choosing The Run Parameters .....	45
3.6 Carrying Out Experimental Runs .....	46
3.7 Using the ThermoVac for Cleaning the ITC Sample Cell.....	47
3.8 Cleaning Syringes.....	49

### 3.1 Designing ITC Experiments

For a ligand **X** binding to a single set of **n** identical sites on a macromolecule **M**, i.e.,

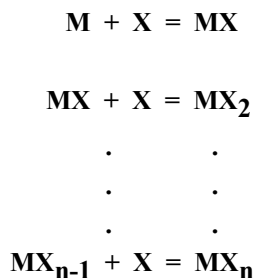

the single-site binding constant is

$$\mathbf{K} = \frac{[\text{filled sites}]}{[\text{empty sites}][\mathbf{X}]}$$

and

$$\Delta\mathbf{G}^0 = -\mathbf{R} \mathbf{T} \ln\mathbf{K} = \Delta\mathbf{H}^0 - \mathbf{T} \Delta\mathbf{S}^0$$

Where  $\Delta\mathbf{G}^0$ ,  $\Delta\mathbf{H}^0$  and  $\Delta\mathbf{S}^0$  are the free energy, enthalpy, and entropy change for single site binding.

By non-linear least squares fit of calorimetric titration data, the parameters **K**,  $\Delta\mathbf{H}^0$ , and **n** are determined directly in a single experiment and  $\Delta\mathbf{G}^0$  and  $\Delta\mathbf{S}^0$  may then be calculated. Titration calorimetry is the only technique capable of defining all of these parameters in a single experiment resulting in nearly complete thermodynamic characterization of the interaction. Measuring the binding isotherm at a second temperature allows additional determination of the change in heat capacity of binding through the relation:

$$\Delta\mathbf{C}_p = \frac{\Delta\mathbf{H}^0_{T2} - \Delta\mathbf{H}^0_{T1}}{T2 - T1}$$



It is well-known that  $\Delta C_p$  is a good indicator of changes in hydrophobic interactions with binding, being negative if hydrophobic bonds are formed and positive if they are broken.

The critical parameter which determines the shape of the binding isotherm is the unitless constant  $c$ , which is the product of the binding constant  $K$  times the total macromolecule concentration in the cell at the start of the experiment,  $M_{tot}$ , times the stoichiometry parameter,  $n$ .

$$c = KM_{tot}n$$

Very large  $c$  values lead to very tight binding and the isotherm is rectangular in shape with the height corresponding exactly to  $\Delta H^\circ$  and with the sharp drop occurring precisely at the stoichiometric equivalence point  $n$  in the molar ratio  $X_{tot}/M_{tot}$ . The shape of this curve is invariant with changes in  $K$  so long as the  $c$  value remains above ca. 5000. As  $c$  is reduced by decreasing  $M_{tot}$  (i.e., holding  $K$ ,  $\Delta H^\circ$  and other parameters constant), the drop near the equivalence point becomes broadened and the intercept at the Y axis becomes lower than the true  $\Delta H^\circ$ . In the limit of very low initial  $M_{tot}$  concentration (cf.,  $c=0.1$ ), the isotherm becomes featureless and traces a nearly horizontal line indicative of very weak binding. It is apparent from looking at these isotherms that their shape is reasonably sensitive to binding constant only for  $c$  values in the range  $1 \leq c \leq 1000$ , corresponding to binding of intermediate strength. We will refer to this range as the "experimental  $K$  window". When available, the middle of the window from  $c = 5$  to 500 is most ideal for measuring  $K$ .

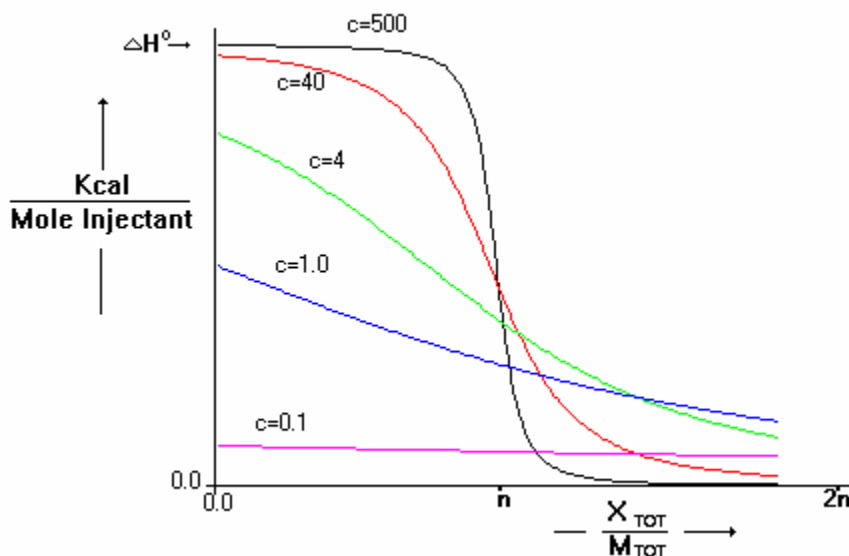

The correct choice of macromolecule concentrations for an experiment depends both on the objective of the experiment (i.e., whether you wish to determine a  $\Delta H^\circ$  of binding only, or whether you wish to determine  $n$  and  $K$  in addition to  $\Delta H^\circ$ ) and upon the magnitude of  $K$ . While considering your choice of starting concentration, it must also be remembered that the limiting

VP-ITC sensitivity is ca. 0.1  $\mu\text{cal}$  so for precise measurement each injection should have an average of at least 3-5  $\mu\text{Cal}$  of heat absorbed or evolved into the 1.3 ml cell.

How these factors impinge on your choice of macromolecule concentration can be seen by considering a particular example of the binding of 2'CMP to ribonuclease A, where the binding constant is approximately  $1 \times 10^6 \text{ M}^{-1}$  and the  $\Delta H^0$  is approximately -15000 cal/mole for the single binding site.

### ***A. Measuring $\Delta H^0$ , $K$ and $n$ by deconvolution of total binding isotherm.***

For a  $K$  of  $10^6$ , RNASE concentrations are in the experimental  $K$  window for the Molar range  $10^{-6} \leq M_{\text{tot}} \leq 10^{-3}$ . It requires at least 10 separate injections to define the total binding isotherms and each injection must average ca. 5  $\mu\text{cal}$ , so the total heat  $Q$  required in the 1.3 ml cell is 50  $\mu\text{cal}$ , i.e.,

$$Q = 50 \times 10^{-6} \text{ cal} = (15000 \text{ cal/mole}) (M_{\text{tot}} \text{ moles/l}) (1.3 \times 10^{-3} \text{ l})$$

Solving this equation for  $M_{\text{tot}}$  gives a minimum concentration of ca.  $3 \times 10^{-6} \text{ M}$ . This concentration is larger than the lowest concentration,  $1 \times 10^{-6}$ , in the experimental  $K$  window so the concentration range available in the  $K$  window becomes  $3 \times 10^{-6} \leq M \leq 10^{-3}$ . Although any value within this range is acceptable, it would lead to better estimates of parameters to choose concentrations higher than the minimum of  $3 \times 10^{-6}$  so that  $Q$  signals will be larger and  $c$  values will be in the ideal range between 10 and 100. (i.e.,  $10^{-5} \leq M_{\text{tot}} \leq 10^{-4}$ ).

### ***B. Measuring only $\Delta H^0$ by single ligand injection into excess macromolecule.***

To measure  $\Delta H^0$  by a single injection (i.e., without deconvolution of the total binding isotherm) requires a  $c$  value large enough so the experimental intercept on the isotherm intercepts the  $Y$  axis very close to the true  $\Delta H^0$ , i.e.,  $c \geq 100$ . This means  $M_{\text{tot}} \geq 10^{-4}$ . Since there will be excess macromolecule in the cell, the experimental heat  $Q$  will be determined by the amount of ligand injected, i.e.,

$$Q = (15,000 \text{ cal/mole}) (\text{syringe conc.}) (\text{inj. vol.})$$

For example, a 10 ml injection of a  $7 \times 10^{-5} \text{ M}$  ligand solution would give the minimal 10  $\mu\text{cal}$  of heat. It is also possible to measure  $\Delta H$  by injecting excess ligand into a very low concentration of macromolecule.

Referring to case A above, once you have chosen  $M_{\text{tot}}$  you must select the ligand concentration  $X_{\text{tot}}$  for the solution to be loaded into the syringe. This will depend on the volume of the syringe

that you plan to use. For  $c$  values larger than ca. 10, the final concentration of ligand in the cell after all injections are completed should be ca. 1.5 times the total concentration of macromolecule binding sites in the cell at the beginning of the experiment,

$$\text{i.e., } X_{\text{tot}} \times \Delta v/V = n \times M_{\text{tot}} \times 1.5,$$

Where  $\Delta v$  is the total volume of injectant to be used,  $V$  is the cell volume (ca. 1.3 ml), and  $n$  is the ligand/macromolecule stoichiometry. For cases where  $n=1$ , the ligand concentration,  $X_{\text{tot}}$ , should be ca. 8.5 times  $M_{\text{tot}}$  using a 250  $\mu\text{l}$  syringe. If the  $c$  value for your system is lower than 10, you may wish to increase the final ligand/macromolecule ratio from 1.5 up to 2.0 or even 2.5 as is evident by referring back to the previous figure showing binding isotherms as they depend on  $c$ . It should be realized however that accurate curve fitting is possible even when saturation of sites is not achieved.

There may be other factors, specific to your system, that are important considerations in experiment design, such as the total amount of macromolecule or ligand that is available for the experiment and/or solubility restrictions on the macromolecule or the ligand.

Several other experimental design problems should be mentioned. First, the buffer in which the ligand is dissolved should be an **exact match** (i.e., pH, buffer concentration, salt concentration, etc.) to the buffer in which the macromolecule is dissolved, or else large spurious heat effects from buffer mixing will result. For example, if the ligand is dissolved directly into the buffer which was dialyzed against the macromolecule solution, the exact pH of the ligand solution may change due to titration of ionizable groups on the ligand. If this happens, then the ligand solution should be back-titrated carefully until the pH is identical to that of the macromolecule solution before doing the experiment.

Second, control experiments (i.e., ligand solution added to buffer in cell without the presence of macromolecule) to determine the heat of dilution of ligand should be carried out in the same way as the experiment with macromolecule present, and these heats of dilution should be subtracted from the corresponding injection into the macromolecule solution. You will usually find these heats of dilution to be small and frequently negligible (unless the ligand dimerizes or aggregates with itself!) but they should be checked as a precaution.

Finally, you may find occasionally that the first injection in a series of injections shows a smaller heat effect than it should. This can result from bending the syringe needle a little when seating the injector into the barrel, or leakage resulting from having the syringe in the cell a long time before the first injection is made (particularly if it is stirring all the while). If you find this to be a persistent problem with certain systems, even when care is taken to avoid the aforementioned factors, you may wish to make a small first injection (e.g. one 1  $\mu\text{l}$  injection followed by ten 10  $\mu\text{l}$  injections) and then delete the first data point before doing curve-fitting in Origin.

Because of release or uptake of protons during many biological binding reactions, the observed heats of binding may be strongly dependent on which buffer is used. In fact, certain binding reactions which have extremely small  $\Delta H$  and produce virtually no signal in buffers with small  $\Delta H_{\text{ion}}$  (e.g., phosphate) can sometimes be studied nicely in buffers with a large  $\Delta H_{\text{ion}}$  (e.g., tris) where the signal will be much larger.

## 3.2 Using the ThermoVac to Degas Samples

Degas cell and syringe samples that may contain dissolved gas to insure bubble free loading of each. This is particularly important if samples recently were at refrigerator temperatures. A ThermoVac sample degassing and Thermostat station is provided with each instrument. The ThermoVac's preset vacuum time of ca. 5 minutes is adequate to degas a sample that is being stirred, but a much longer time is required without stirring. Normally, you would set the ThermoVac temperature to 1 to 5 degrees below the intended experimental temperature while degassing. If volatile buffers or ligands are being used then solutions should be prepared from degassed or pre-boiled water and stored air-free. If sample solutions contain any undissolved solutes or extraneous solid material of other types, they should be filtered before use.

Please note: When running experiments below ambient temperature, the temperature of the sample should be such, that after loading into the cell, it is at or below the experimental temperature. This will prevent a long equilibration period before the experiment can start (see page 82 for more information). Therefore, if running an experiment much below room temperature you may wish to set the ThermoVac temperature 5 degrees below the experimental temperature, as the sample may warm up during the transfer to the calorimetric cells. Additionally, the temperature of the filling syringe itself will act to change the sample temperature during cell filling. For this reason users may consider using a cold syringe (stored in a refrigerator) to minimize the sample temperature change during cell filling. The temperature of the injection syringe sample has little effect on the equilibration period.

### *Top View of ThermoVac*

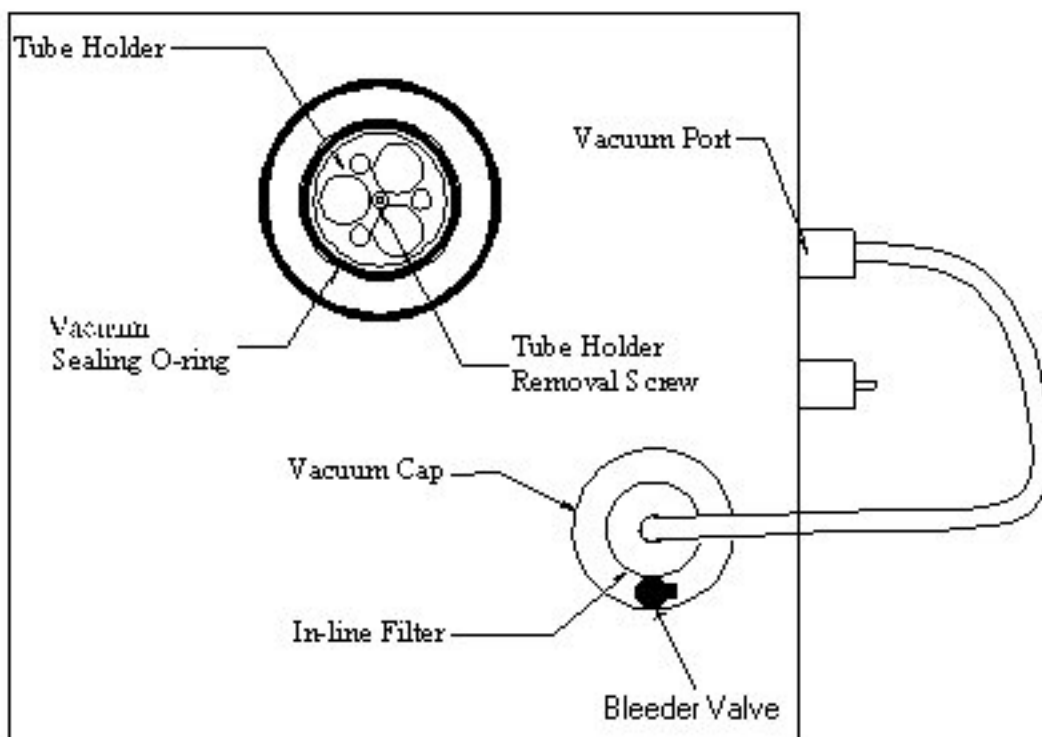

**Note:** The ThermoVac includes a preinstalled bleeder valve on the top of the vacuum cap to allow manual adjustment of the vacuum strength in the degassing chamber. If the vacuum is

boiling the sample in the chamber you should adjust the adjusting knob of the bleeder valve counterclockwise to reduce the vacuum. Any customers with a ThermoVac that does not include this option may request one through our sales department.

To degas solutions before placing into the cells or injection syringe, please do the following.

- Turn on the Power Main Switch.
- Set the desired temperature for the solution.
- Place your solution to be degassed into a test tube, add a small stir bar and place the tube into one of the open cylinders of the Tube Holder insert.

*Please Note:* To conserve titrant sample for loading into the injection syringe, use the small test tubes provided with the ThermoVac.

If you wish to use a tube or beaker larger than will fit into the Tube Holder you may remove the Tube Holder by simply lifting it up. Due to the tight fit of the Tube Holder, it may be difficult to lift the Tube Holder out of the sample chamber, in this case you may use a 3/32" hex (Allen Key) wrench to turn a screw, located at the bottom of the center hole of the Tube Holder, to lift the Tube Holder out.

- Turn the stirring on.
- Turn on the vacuum. Push the switch to the right to activate the vacuum for a preset (ca. 5 minutes) duration. Push the switch to the left if you wish to manually control the time for the vacuum. If excessive bubbling occurs that could boil over your sample you may adjust the bleeder valve. Turning the adjusting knob clockwise will increase the vacuum while a counterclockwise turn will decrease the vacuum strength.
- Place the Vacuum cap on top of the sealing o-ring. The sound of the vacuum pump will change pitch to indicate the vacuum has sealed the Cap to the o-ring. Once the vacuum has sealed, the Vacuum Cap will be held firmly in place, until the vacuum pump shuts off.

*Please Note:* Once the vacuum pump has been turned off, the vacuum in the sample degassing chamber may be released at any time causing the Vacuum Cap to fall off the sealing o-ring. Make sure that there is nothing on top or next to the ThermoVac that may spill or break due to the sudden movement of the Vacuum Cap.

For the first 30 seconds after the vacuum pump is turned off, the vacuum in the sample degassing chamber may remain fairly tight making the removal of the Vacuum Cap difficult. During this period, the easiest way to release the vacuum is to open the bleeder valve by turning the adjusting knob counter-clockwise.

### 3.3 Cell Loading

The cells are filled using the long needled 2.5 ml glass syringe, by filling from the bottom of the cell to the top. The tops of the access tubes are visible within the cell port. The sample cell is in the center and the reference is offset to the left, as viewed from the front of the instrument.

- Degas the sample, as described in the previous section.
- Slowly draw a minimum of 1.8 ml of solution into the filling syringe. (It may be advantageous to fill using more solution, but after filling, you should remove all but the 1.8 mL that is in the cell and access tube).

- Remove all air from the filling syringe, or tap the syringe glass so that all air is at the top volume of the syringe. Do not allow air to be put into the cells.
- After removing the bubbles, insert the syringe into the cell and gently touch the bottom of the cell with the tip of the syringe needle. Raise the needle tip about 1 mm off the bottom of the cell. The syringe will remain at this location for the duration of the filling procedure. Do not raise the syringe during the filling process.
- Slowly inject solution into the cell until you see it spill out the top of the cell stem. Finish the filling with an abrupt spurt of ca. 0.25 ml of solution into the cell. If possible, repeat the 0.25 ml abrupt spurt of solution one or two times. This bursting of .25 ml of solution will help remove bubbles that may rest on the edges of the coin shaped area where the junction of the stem is.
- The final step is to drain off the solution overflow. Do this by gently inserting the tip of the syringe into the cell port (just below the visible portion of the cell port) and find the ledge that is formed where the cell stem meets the cell port. Place the syringe on the ledge at the top of the metal cell stem and remove the excess solution.
- Fill the reference cell with water, as above, then remove any excess water. To prevent sample overflow into the reference cell, cap the reference cell with the Reference Plug. *Please Note:*

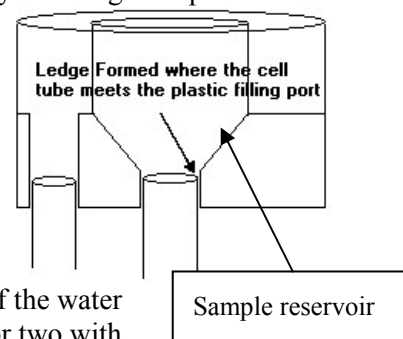
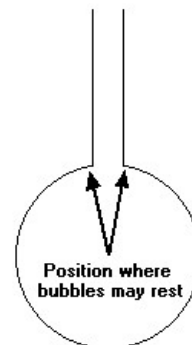

There is no need to refill the ITC reference with each experiment. If the water was thoroughly degassed before filling, it may be good for a week or two with no attention.

## A Word of Caution

If the reservoir should overflow during the filling procedure, the fluid may contaminate the stir motor bearing and damage it beyond repair. Care should be taken not to over flow the reservoir. If an overflow does occur, the injector should be removed and the bearings on the underside should be wiped dry. If internal contamination is expected you should consult with MicroCal personnel for further recommendations.

## 3.4 Loading the Auto-Pipette

Please refer to the diagram below.

- Degas the titrant for ca. 5 minutes and place in the pipette filling tube.
- The pipette filling tube should be placed into the bottom of the stand.
- Carefully, insert the auto-pipette into the pipette stand.

**!** **Caution:** Be careful not to hit the long needle of the injection syringe against any object, as this could cause the needle to bend and expel some solution from the syringe and result in a poor first injection for the experiment. If the long needle is bent far enough it may cause a permanent deformation in the needle making the syringe unusable for future experiments.

- Select the ITC Controls window. In the lower right corner you will find the Pipette Controls button.

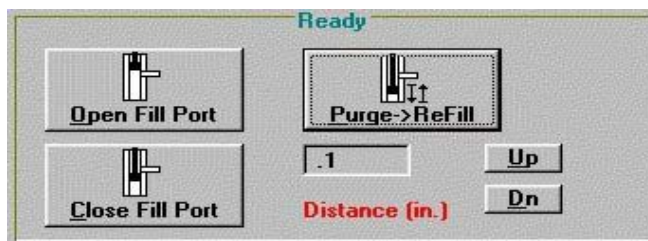

- Click on the **Open Fill Port** button.

The auto-pipette will move the plunger of the injection syringe till the Teflon tip is just above the filling port of the syringe. You should hear a beep when the movement is complete.

- Attach the tube of the **plastic filling syringe** to the **filling port of the injection syringe**.

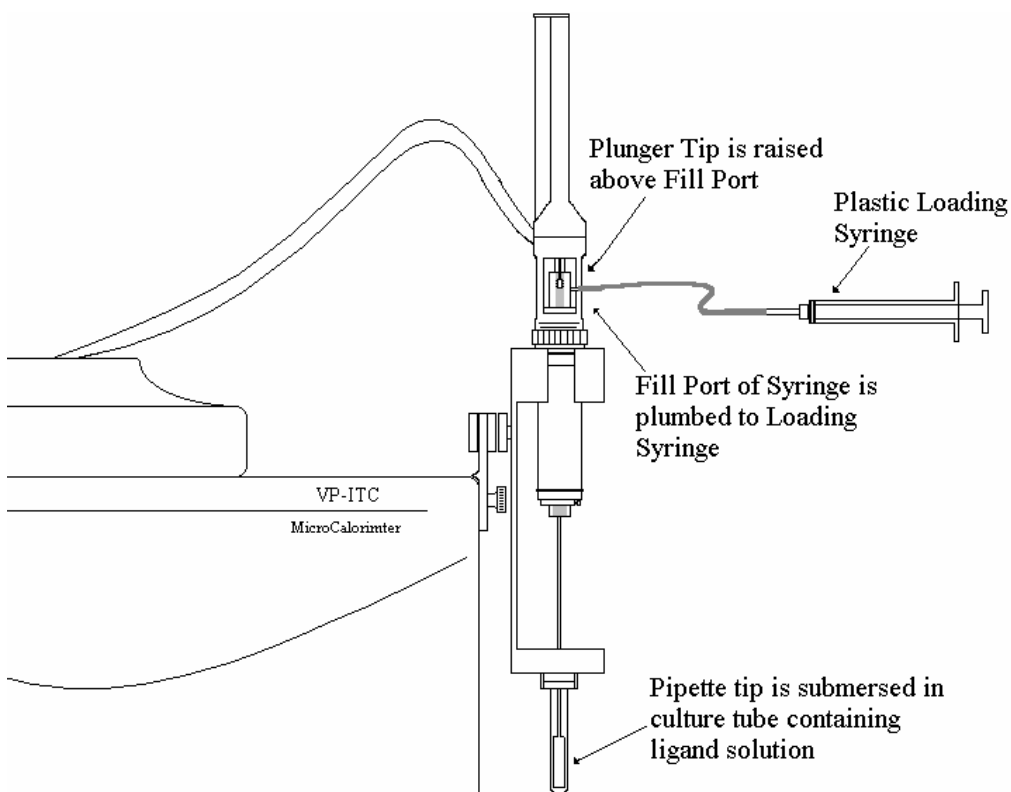

- Slowly withdraw the plunger of the plastic filling syringe to draw up the titrant solution until you see the solution exit through the top filling port.
- Click on the **Close Fill Port** button as soon as you see the liquid exit the top filling port. The pipette will lower the plunger of the injection syringe till the white Teflon tip is completely below the filling port (ca. 4mm). You should here a beep when the movement is complete.
- Remove the hose of the plastic filling syringe from the filling port of the injection syringe.
- Click on the **Purge->ReFill** button. The auto-pipette will depress the plunger of the filling syringe to inject the sample back into the filling test tube, then raise the plunger to refill the injection syringe. When the movement

is complete the tip of the injection syringe will be positioned to its original position, just below the filling port. A beep will indicate the completion of the movement.

- Click on the **Purge->ReFill** button again to repeat the purge/refill action.  
The purpose of both purge/refill procedures is to dislodge any air bubbles from inside walls of the injection syringe (which may have occurred during the first filling) and expel them back into the titrant solution.
- Carefully remove the pipette from its stand by picking it straight up until the glass barrel of the injection syringe is above the top part of the pipette stand.
- Carefully move the pipette so that it is directly above the center positioned sample cell access tube (this is the hole on the right).
- Carefully insert the pipette into the sample cell access tube.  
Watch the end paddle of the long needle to insure it is inserted directly into the access hole, hold the pipette vertical and slowly lower the pipette. When the pipette is almost completely inserted you may have to push down slightly to compensate for the resistance of the rubber o-ring to seat the pipette.

### ***Precautions with Pipettes***

**Never assemble or disassemble the pipette/syringe assembly when the pipette screw is not in its home (open port) position. Failure to raise the pipette screw prior to assembling/disassembling the assembly will likely bend the pipette screw beyond repair.**

**The long needle and stir paddle on the pipette injection syringe must not be bent even slightly** or baseline stability will be compromised. Exercise care at all times in the handling of the pipette syringes. .

When removing the pipette from the instrument after an experiment ends ensure that the needle is concentric with the access tube until the end of the stir paddle is clear of the hole. The syringe should then be cleaned, dried, and stored safely.

The Pipette Stand is used to hold the pipette during filling, or merely for safekeeping. Users should be aware that damage to the pipette injection syringe needles might be incurred when placing them into the Pipette Stand. It is good practice pay close attention to the bottom tip of the syringe needle paddle when inserting the injection syringes into the Pipette Stand. Do not place the pipette assembly into its stand until you are sure that there is clearance between bottom tip of the syringe paddle and the filling tube.

The user should be aware that the design of the VP-ITC instrument is such that during an experiment the syringe barrel is spinning (usually at ca. 310 RPM) while the plunger and Teflon tip remain stationary. This causes the Teflon tip to wear away so eventually there will no longer be a proper seal and the solution in the injection syringe may leak or not be properly injected. The user should note the proper clearance between the plunger tip and glass syringe barrel and replace the tip when the wear of the tip seems excessive. **When using the VP-ITC daily, we recommend replacing the syringe tip once a month.**



## 3.5 Choosing The Run Parameters

Prior to carrying out a ITC run, the experimental run parameters must be entered into the *ITC Controls* window. Run parameters may also be loaded from a parameter setup file (\*.inj) or a previous experimental file (\*.itc). (Refer to Section 2.4 ITC Controls Window for more information). Selecting the proper run parameters depend on the sample you will be using. This section will attempt to provide you with general guidelines for selecting run parameters.

The **Total Number of Injections** will, in part be determined by your experimental design and the setting of concentrations. You will need a minimum of 10-15 injections to define a binding isotherm. There are no negative consequences to ‘over-injecting’ (titrating beyond the saturation of binding sites) and doing so will often times provide you with ‘control heat’ information within the same experiment.

The **Cell Temperature (°C)** is determined by your experimental requirements. Typically, the binding constant and heat of binding will be temperature dependent, but the stoichiometry of binding will not be. The ITC’s operating range is 2° to 80°.

The **Reference Power (µCal/sec)** setting determines the approximate value that the baseline will settle at when the system is equilibrated. Measuring large exothermic reactions will require a ‘large’ reference power of about 30 uCal/sec., while large endothermic reactions will require a low reference power setting of about 2 uCal/sec. If you have little information about the expected heats it will be best to use a reference power setting of 15-20 uCal/sec.

The **Stirring Speed** is typically set at 310 RPM. Faster stir speeds may be necessary if solutions are more viscous than water, or if particle suspensions need to be maintained. Faster stir speeds will increase the baseline noise level.

The injection **Volume (µl)** is generally between 3µl and 15µl. This range ensures high volumetric accuracy while allowing enough time for the injectant to equilibrate to the temperature of the cell before injection. The injectant equilibrates to the cell temperature in the stem prior to reaching the cell. Injections at the high end of this range or larger may result in a reduction in the repeatability of the *injection blank* heat. The injection blank heat is the thermal energy associated with the force of the injection and any temperature differences between the cell volume and the injection volume. A water into water experiment will show the injection blank heat.

The **Duration (sec.)** of the injection is usually left at the default value, which yields an injection rate of .5 µl/Second. Very subtle changes in control peak shapes and sizes can be obtained by varying the injection duration, and is not usually beneficial.

## 3.6 Carrying Out Experimental Runs

### *Starting the Run*

After the run parameters are entered, the experiment is started by clicking on the **Start** button at the top of the VPViewer window (as show below).



If a data file name has been specified which would result in overwriting an existing data file, the user will be asked if he/she wants to overwrite the existing file.

### *Changing Run Parameters During an Experiment*

To change run parameters, open the ITC window, make changes, then select the **Update Run Parameters** button. If there is confusion about what was or was not changed the **Display Run Parameters** button will show the current run parameters. The software will not allow you to change parameters that would adversely affect the experiment.

### *Completion of the Run*

The run may be terminated at any time by selecting the **Stop** button. If the run is not prematurely terminated the software will complete all the injections, then thermostat at the *post run thermostat* temperature.

### *Cleaning After the Run*

The VP-ITC sample cell need not be cleaned with detergent solution after each experiment, since rinsing with water or buffer from a syringe is often adequate. However, after every 3-5 experiments (or at the end of each day's experiments) solids that cannot be removed by rinsing will adhere to the cell interior and these can cause baseline problems if not removed periodically by a thorough cleaning with a detergent solution.

Once the run has completed the sample should be immediately removed from the cell and inspected. If the sample is cloudy, or contains aggregates, then cleaning may require a more aggressive methodology. If aggregates are found the cells should be manually rinsed with a cleaning solution prior to the normal cleaning to facilitate removal of contamination too large for the cleaning device to wash away. The instrument should be cleaned thoroughly. It is advisable to record the condition of the sample after the experiment has concluded. This may provide information on particularly difficult samples to clean.

The importance of maintaining cleanliness cannot be stressed enough, please refer to *Section 3.7 Using the ThermoVac for Cleaning the ITC Sample Cell*, *Section 3.8 Cleaning Syringes*, and *Section 5.1 Cleaning The Cells and Pipette* for more information

### 3.7 Using the ThermoVac for Cleaning the ITC Sample Cell

The ThermoVac may be used to flush copious amounts of detergent solution followed by a thorough rinse with distilled water.

- Insert the Cell Cleaning Apparatus into the Adapter, until the top flange is touching the top of the Adapter (see below).
- Insert the long needle into the Sample cell and push down carefully until the o-ring has sealed, as shown below.

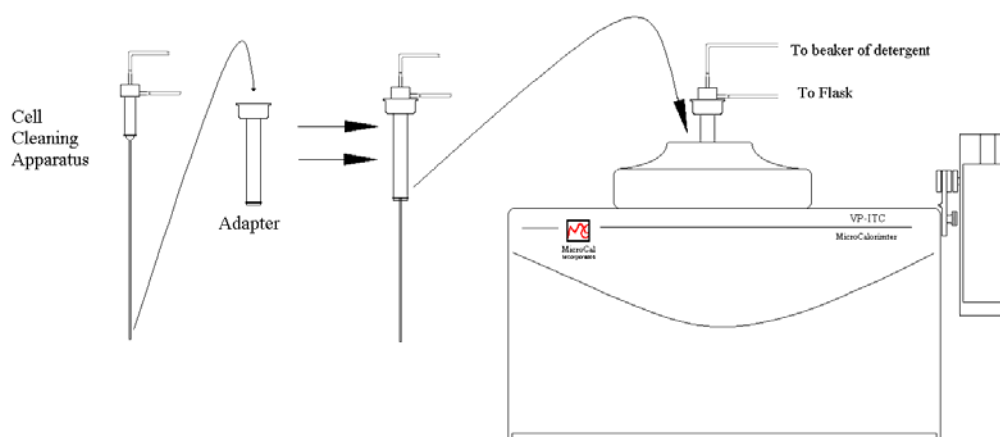

- The end of the plastic tubing from the upper tube of the Cell cleaning Apparatus is immersed into a beaker of 200-400 ml of detergent cleaning solution.
- The end of the plastic tubing from lower tube is connected to a one liter vacuum flask through the #8 rubber stopper.
- The side arm of the vacuum flask is attached to the Vacuum Port of the ThermoVac. Your Setup up should look like below.

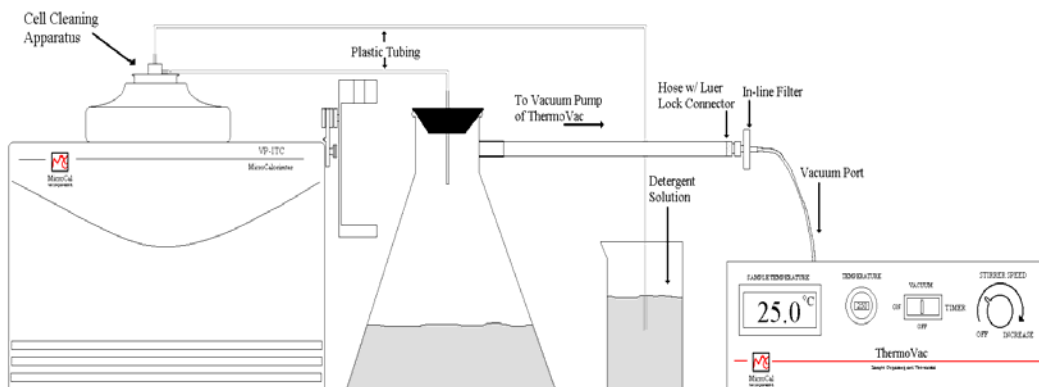

- Turn on the ThermoVac vacuum pump. The vacuum will pull the detergent solution from the beaker, through the cell and into the waste flask. **NOTE: DO NOT ALLOW THE VOLUME OF FLUID IN THE WASTE FLASK TO BECOME SUCH THAT IT WOULD RISE UP TO THE LEVEL OF THE SIDE ARM AND BE SUCKED INTO THE THERMOVAC'S VACUUM PUMP. THIS MAY CAUSE THE PUMP TO BECOME DAMAGED.**
- Once sufficient detergent solution has passed through the cell, the plastic tubing is removed from the solution, rinsed free of detergent using a plastic wash bottle, and then placed into another beaker containing 300 ml or more of water for rinsing.
- After rinsing with water, remove the plastic tubing from the rinse water and allow time for the vacuum to drain the fluid out of the plastic tubing, then remove the cleaning apparatus from the cell.
- Remove the remaining water from the cell by using a long needle syringe.

We do not recommend drying the cell before filling with your sample solution, but it should be rinsed twice with the buffer you are using for the experiment. Finally, it should be completely drained and filled with your sample solution in the manner described earlier.

Because a small amount of the buffer used for final rinsing will adhere to the walls of the cell and act to dilute your sample solution, you may wish to correct for this by lowering your sample concentration by 2% if you measured concentration before the sample was introduced into the cell.

## 3.8 Cleaning Syringes.

### *Cleaning Injection Syringes*

- Disconnect the syringe from the pipette and insert the accessory plunger into the top of the syringe.
- Attach the plastic loading syringe tube to the filling port at the top of the syringe
- Insert the tip of the injection syringe into the cleaning solution and draw  $\geq 2$ ml of solution through the syringe
- Empty the plastic loading syringe and repeat the above step at least two more times.
- Insert the tip of the injection syringe into distilled water and draw  $\geq 2$ ml of solution through the syringe
- Empty the plastic loading syringe and repeat the above step at least two more times.
- Insert the tip of the injection syringe into HPLC Grade methanol and draw  $\geq 2$ ml of solution through the syringe.
- Empty the plastic loading syringe and reattach it to the port. Remove the accessory plunger. Reattach the plastic loading syringe.
- Apply vacuum to the glass end of the injection syringe using the vacuum tube attachment for approximately 10 minutes to dry the methanol.

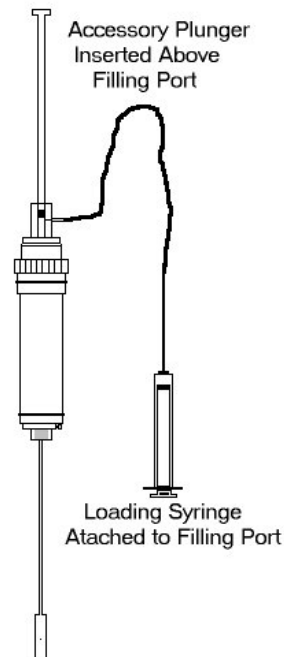

If it is necessary, the cleaning brush (included with accessories) may be used to scrub the inside diameter of the syringe glass. Additionally, there is a cleaning wire included with the ITC accessories that can be used to clean out the small delivery hole that is located on the very end of the twisted paddle of the titration syringe. Care should be used to avoid bending the syringe during this procedure.

### *Cleaning The Filling Syringes*

Cleaning the syringes may be accomplished by various methods. The filling syringes are generally soaked in a cleaning solution and briefly scrubbed internally with a soft brush. The filling syringes are then rinsed thoroughly at a sink with distilled water. The syringes are often dried with HPLC grade methanol and a dry air or vacuum source. They may also be left out to air dry but this method is not as reliable as forced drying. *Please Note: Do not leave any methanol residue in the syringe as it would ruin the next experiment.*

## Section 4: Experimental Tutorials

Once the VP-ITC is setup and running properly, new users may proceed directly to the tutorials in this section for a 'hands-on' approach to learning the instrument. When more detail is required about the software or experiment the user may refer back to sections 2 or 3.

The water-water tutorial provides the user experience in loading the pipette and cells. Obtaining small and repeatable water into water injections will serve to establish faith in the ITC and techniques of operation. The methanol-water tutorial will closely mimic a typical titration experiment with respect to the size of the heats. Finally the Rnase-2'CMP provides a real experiment to be analyzed and compared with the results obtained with your instrument at MicroCal.

The following experimental tutorial is designed to acquaint you with the basic features of both the hardware and software of the VP-ITC instrument, as well as to provide experience with several manipulations that must be mastered in order to get the highest quality data from your instrument. Rather than beginning experimentation on the VP-ITC using precious biological samples, we strongly suggest that each new user of the VP-ITC instrument complete the following tutorials first

This section is arranged as follows:

<b>Section 4: Experimental Tutorials .....</b>	<b>50</b>
4.1 Water-Water Baselines .....	51
4.2 Methanol Tutorial .....	60
4.3 Rnase-2'CMP Experiment Tutorial .....	63

## 4.1 Water-Water Baselines

The following experimental tutorial is designed to acquaint the new user with the basic features of both the hardware and software of the VP-ITC instrument, as well as to provide experience with several manipulations that must be mastered in order to get the highest quality data from your instrument. Rather than beginning experimentation on the VP-ITC using precious biological samples, we strongly suggest that each user of the VP-ITC instrument complete the following tutorials first.

The recommended procedures for preparation of solutions, degassing, filling the cell and injection syringe, etc. have already been discussed in the previous sections, while conducting the following tutorials you may want to refer to these sections for more detail.

### *Power Up the System*

Power up the Computer Controller and VP-ITC, doing the following steps in order.

1. Turn on the computer controller. The VP-ITC power switch must be off.
2. Once the computer controller is on and Windows is running, turn on the power switch at the rear of the VP-ITC.
3. Launch the VPViewer application by double clicking its icon on the Windows desktop or from the Windows taskbar by selecting **Start : Programs : MicroCal's VPITC : VPViewer ITC.**



### *Degas Samples*

Begin by degassing (with stirring) ca. 40 ml of distilled water for ca. 5 minutes using your ThermoVac (see page 40 for more information), or suitable substitute. This degassed water will be the solution that will go into the sample cell, reference cell and syringe.

### *Fill the Cells*

Load the 2.5ml glass-filling syringe with water, and while holding the syringe vertically, tap the syringe bottom after loading so all bubbles float to the top surface. Enter the needle into the sample cell entry tube (this is the center hole located to the right of the reference entry hole) and carefully slide the needle down the tube until it just touches the bottom of the cell. Lift the syringe so that the needle end is just off bottom (about 1 mm), then slowly depress the plunger so that the cell fills from the bottom up. After ca. 1.8 ml of the degassed water has been entered, you will be able to see the water come to the top of the small entry tube. Once you see the liquid level rise above the top of the access tube, depress the plunger very quickly 1-3 times to deliver abrupt bursts of ca. 0.25 ml. The purpose of these last bursts is to dislodge any bubbles, which might be clinging where the entry tube joins the cell.

If the reference cell has not previously been filled with degassed water, then carry out the same procedure to fill it. There is no need to refill the reference cell with each experiment, A water reference may be good for a week or two with no attention, if the water was thoroughly degassed before filling. To prevent sample overflow into the reference cell, a reference plug and insertion device has been provided to cap the reference cell access tube after filling.

Now that the cells are filled, it is a good time to check the VP-ITC thermostat temperature and make sure it is set to the desired run temperature of 30 degrees. If the current thermostat temperature is not set to 30 degrees, set it now.

### ***Load the Pipette***

Please refer to the diagrams below.

- Place the water titrant into the pipette filling tube.
- Place the pipette filling tube into the bottom of the pipette stand.
- Carefully, insert the auto-pipette into the pipette stand.

**! Caution:** Be careful not to hit the long needle of the injection syringe against any object, as this could cause the needle to bend and expel some solution from the syringe and result in a poor first injection for the experiment. If the long needle is bent far enough it may cause a permanent deformation in the needle making the syringe unusable for future experiments.

- Select the ITC Controls window. In the lower right corner you will find the Pipette Controls button.

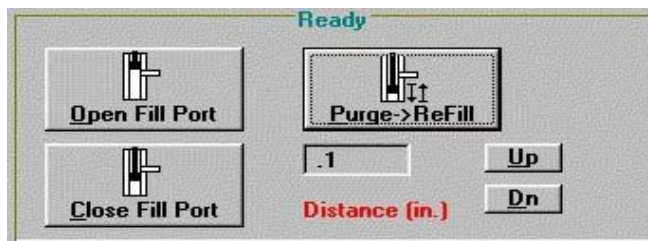

- Click on the **Open Fill Port** button. The auto-pipette will move the plunger of the injection syringe till the Teflon tip is just above the filling port of the syringe. You should hear a beep when the movement is complete.
- Attach the tube of the **plastic filling syringe** to the **filling port of the injection syringe**.



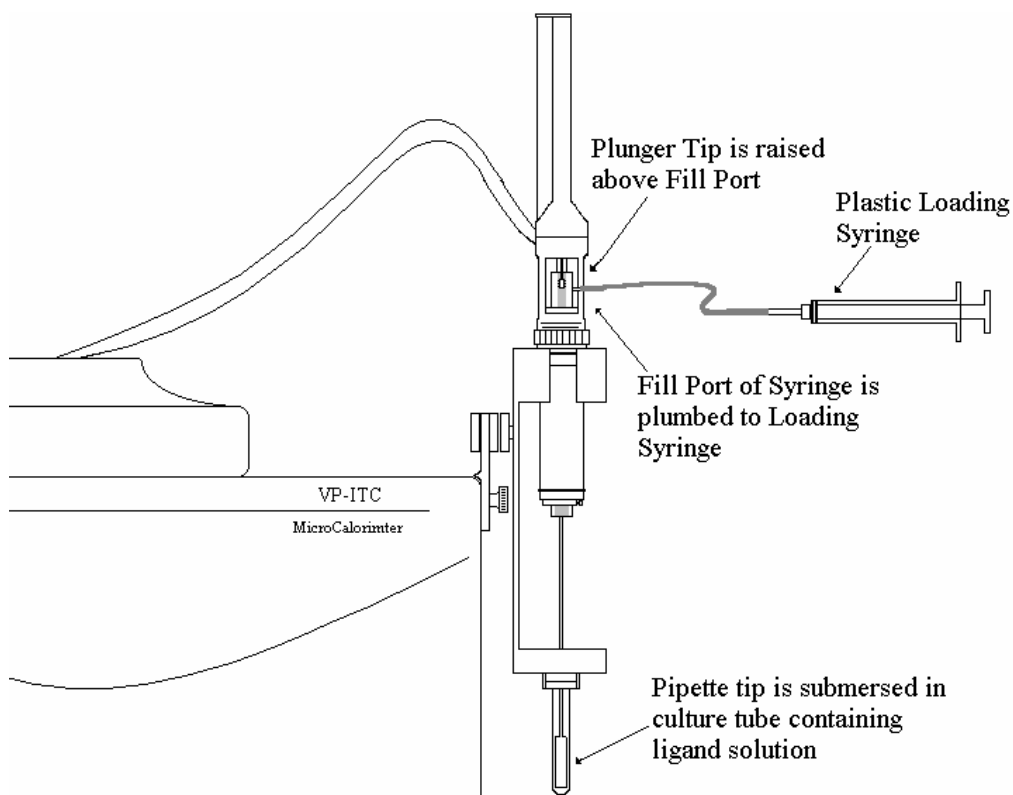

- Slowly withdraw the plunger of the plastic filling syringe to draw up the titrant solution until you see the solution exit through the top filling port.
- Click on the **Close Fill Port** button as soon as you see the liquid exit the top filling port. The pipette will lower the plunger of the injection syringe till the white Teflon tip is completely below the filling port (ca. 4mm). You should here a beep when the movement is complete.
- Remove the hose of the plastic filling syringe from the filling port of the injection syringe.
- Click on the **Purge->ReFill** button. The auto-pipette will depress the plunger of the filling syringe to inject the sample back into the filling test tube, then raise the plunger to refill the injection syringe. When the movement is complete the tip of the injection syringe will be positioned to its original position, just below the filling port. A beep will indicate the completion of the movement.
- Click on the **Purge->ReFill** button again to repeat the purge/refill action. The purpose of both purge/refill procedures is to dislodge any air bubbles from inside walls of the injection syringe (which may have occurred during the first filling) and expel them back into the titrant solution.
- Carefully remove the pipette from its stand by picking it straight up till the glass barrel of the injection syringe is above the top part of the pipette stand.
- Carefully move the pipette so that it is directly above the center positioned sample cell access tube (this is the hole on the right).

- Carefully insert the pipette into the sample cell access tube.  
Watch the end paddle of the long needle to insure it is inserted directly into the access hole, hold the pipette vertical and slowly lower the pipette. When the pipette is almost completely inserted you may have to push down slightly to compensate for the resistance of the rubber o-ring to seat the pipette.

### Enter the Run Parameters into VPViewer

- Select the *Load Run File* button from the main window buttons.



- Select the water.inj run parameters file and click Open.

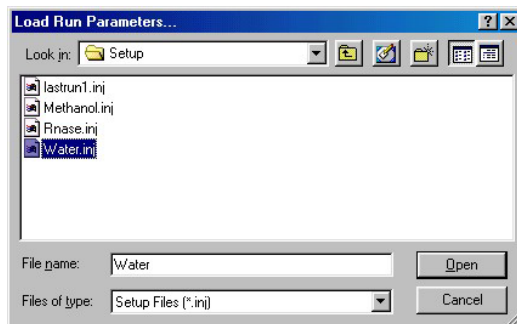

The ITC Controls window will show run parameters for the water experiment.

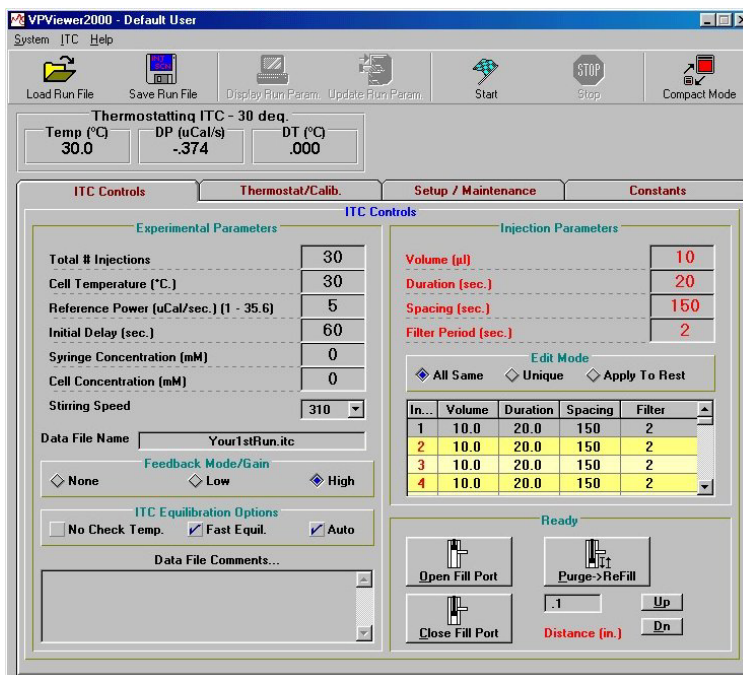

- You may enter a filename or accept the default.itc name. *Refer to page 23 for Data File Name conventions.*
- Select the *Start* button, to start the experiment.



You may receive the query displayed below. This is simply indicating that you have not entered a concentration. This entry is irrelevant for the water experiment and you may select “yes” and continue. If you were conducting a binding experiment you should enter the concentrations so that they may be saved in the raw data file. Failure to do so will require the data to be entered into Origin data analysis.



## Observe the Baseline while Equilibrating

At the start of the experiment the instrument may rapidly bypass certain stages of operation. If the instrument's temperature is at the selected starting temperature the instrument will skip the seeking temperature and pre run thermostating phase and move immediately on to the final baseline equilibration phase. If your instrument is not at the entered starting temperature you may have to wait an extended period of time prior to the final baseline equilibration state. The states of operation are displayed in VPViewer and Origin at the top, right in red. Displayed below is data from an instrument that started at a temperature lower than the desired experimental temperature and is showing the temperature rising to 30 degrees and stabilizing at the starting temperature.

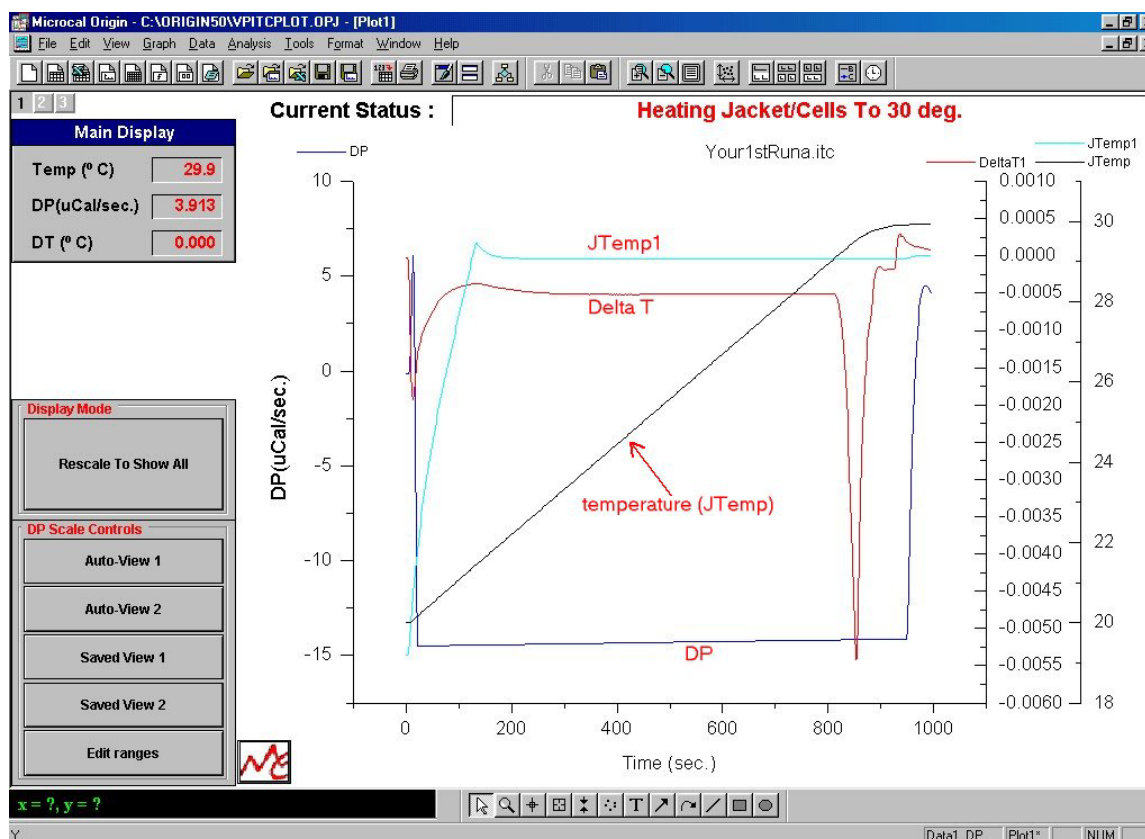

Displayed above are three different Y-axis scales with four different data sets being plotted in the graph. Each Y-axis is plotted in its own layer (see Origin User's Manual for more information about layers). You can see the layer button located in the upper left corner of the graph. The black number on the gray button indicates the active layer while the inactive layers have white numbers. You may set a layer as active by clicking on the layer button or on the corresponding Y-axis.

The Y-axis on the left is colored blue and the data set plotted in this layer (also colored blue) is the DP data (DP data is the differential power between the reference and sample cell). When Pre-stirring equilibration is first started the data may not be visible on the graph. One can click on the **Auto-View 2** button to center the current data point with a Y-axis full scale of 1. When the cell

has equilibrated in the Pre-stirring mode you may want a closer look at the data, so click on the **Auto-View 1** button. This will put the current data point at the center of the graph with a Y-axis full scale of 0.1.

You may notice that when the graph first appears in Origin, the DP data display box in VPViewer's main window has the values displayed in red. Once VPViewer determines that the cell has equilibrated in the Pre-stirring mode, the data display will turn to green. This means that the cell is ready to enter the stirring mode of equilibration. Since **Auto Start** in the **ITC Equilibration Options** group was enabled in the **ITC Controls** window, VPViewer will automatically start the stirring and apply power to the reference cell, moving on to the next state of the equilibration process. If this option was not selected the DP value that turned green becomes a button that will move the instrument to the next state when it is selected.

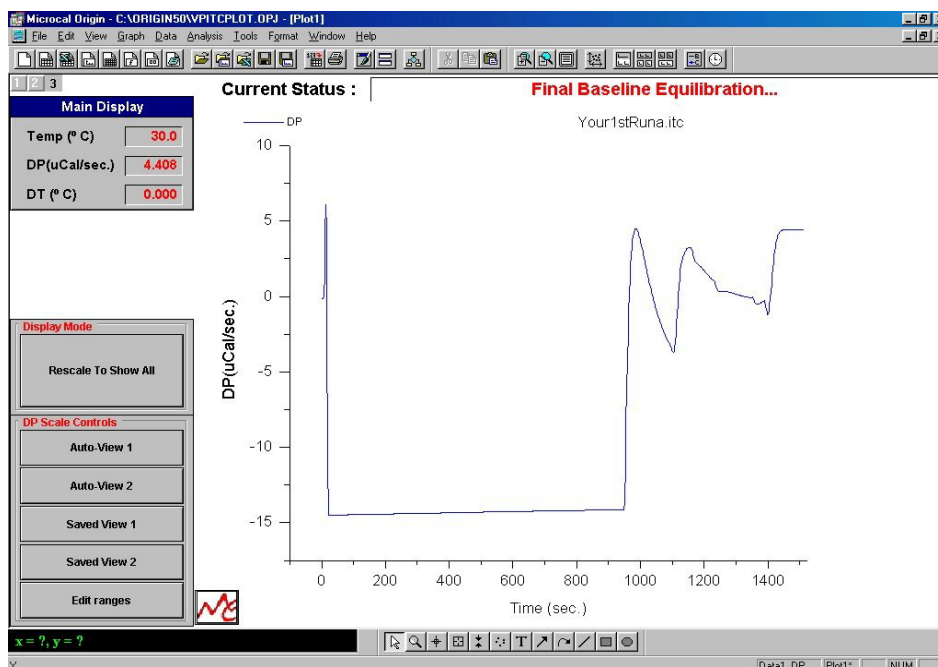

When VPViewer starts the **Final Baseline Equilibration** it starts the stirring and applies power to the reference cell. The amount of power applied to the reference cell is determined by what you entered into the **Baseline Position (μCal/sec)** text box located in **ITC Controls** window. For this tutorial we entered 5 for the Baseline Position, you may see that there may be an initial decrease in the DP power (due to the added frictional energy in stirring), but then the DP values will increase because of the power applied to the reference which forces the feedback system to apply power to the sample cell to compensate and maintain a temperature balance. The effect of this heat disturbance will take a few minutes for a new equilibration level with the final DP values being close to 5. Select the *Rescale to Show All* button and you will see a graph similar to the above.

You may want a closer look at the final baseline before proceeding. Click on the **Auto-View 1** button. You should see a view similar to that below.

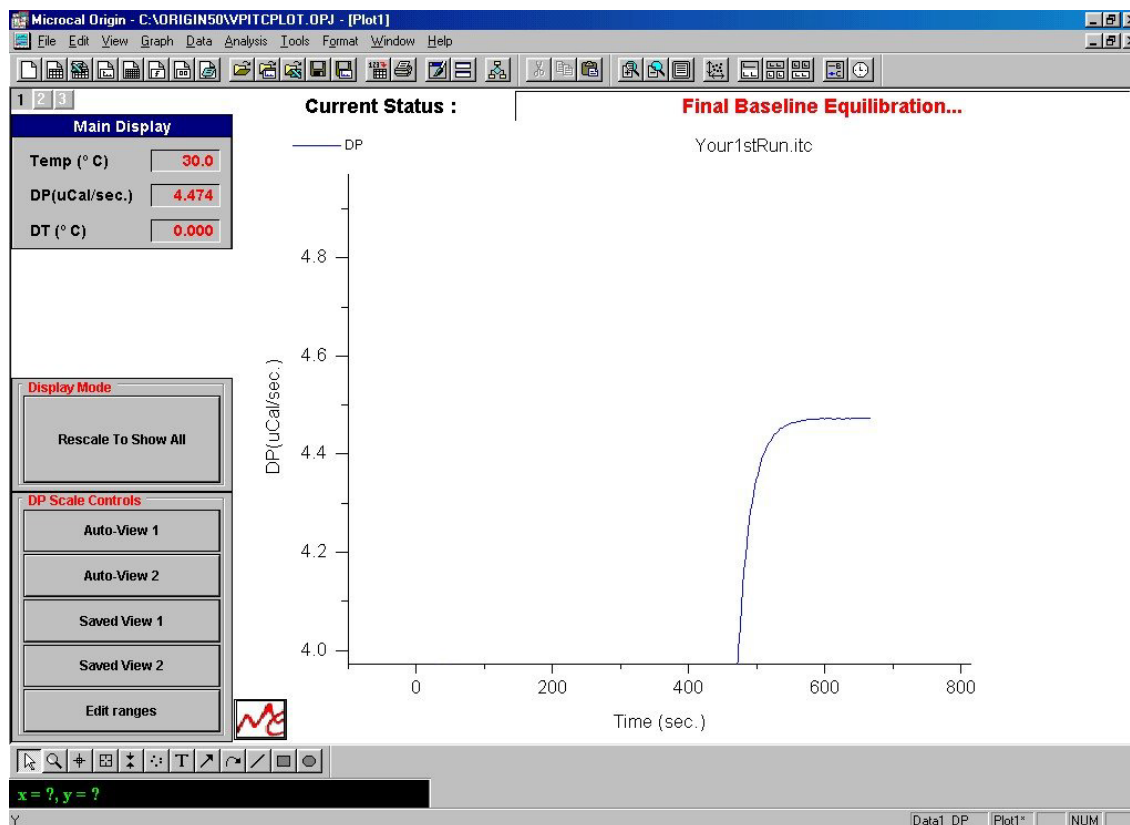

When VPViewer determines that the Final Baseline has equilibrated properly, the display in the DP box will turn from red to green. Since **Auto** was checked in the **ITC Equilibration Options** group, VPViewer will automatically start the experiment. (If the automatic mode was disabled you would now need to double-click anywhere in the **DP** display box, to start the experiment).

The experiment will begin, the **DP** display box will turn from green to black and the display title will read Pre-Titration delay and then print the volume of solution that is left in the syringe. The Pre-Titration Delay is required for an initial baseline for the first injection of the experiment. The time period for this initial baseline was entered in the **Initial Delay** text box located in the **ITC Equilibration Options** group of the **ITC Controls** window.

### ***Observing the Experiment***

After a few injections you may want to view the injection peaks.

*Please note:* While running VPViewer and switching between application you may sometimes see gaps in your data or no data being plotted, select **Window:Refresh** to see all the plotted data.

- Select **Auto View 2** and you should see a plot similar to the one below.

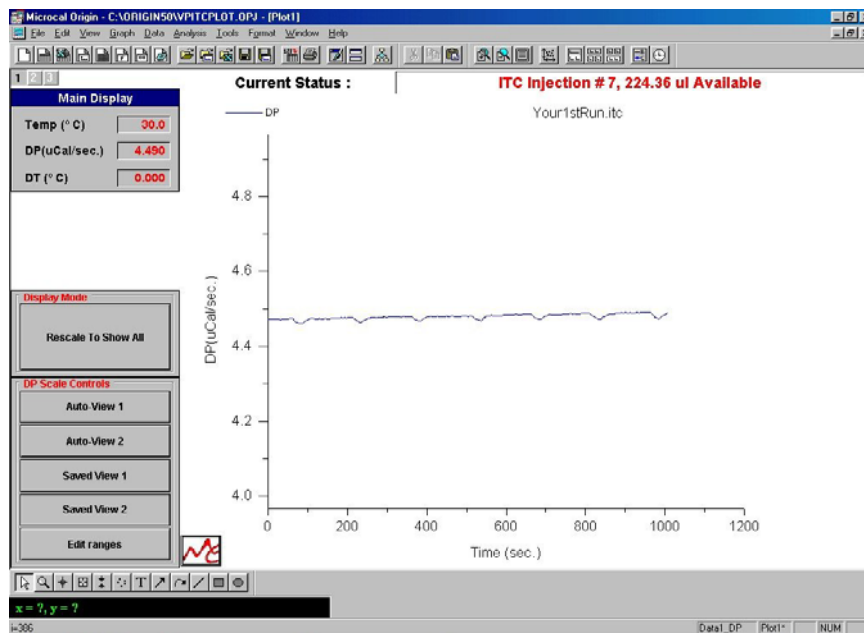

You may also want to get an even closer look at the baseline.

- Click on **Auto View 1** button.

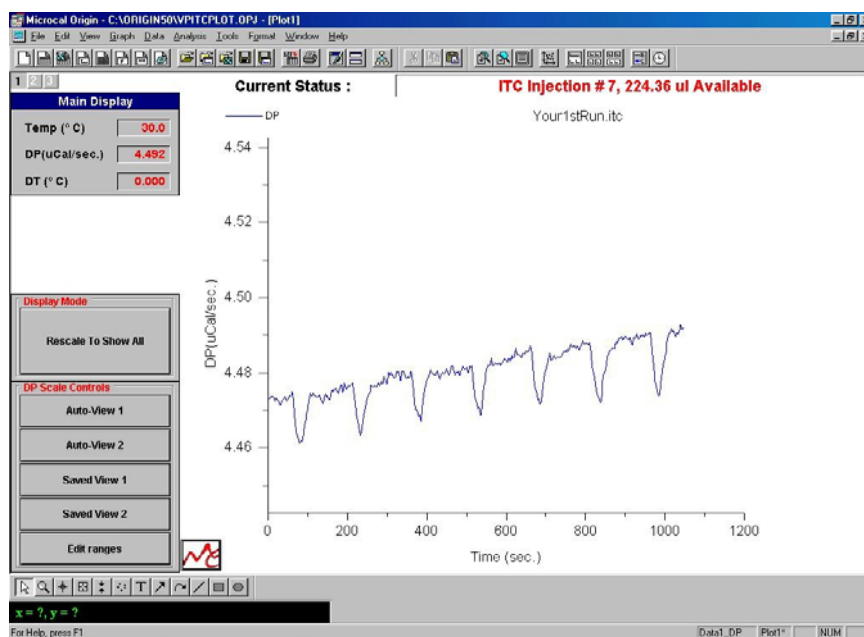

Using a y axis display range of 0.1  $\mu\text{Cal}/\text{sec}$ . And an x axis display range of 20 minutes (1200 sec.), your baseline should look similar to that shown above. The slope and shape of the peaks may be different, but the peaks should look similar to each other.

- Allow all 30 injections to be completed, if they are similar to each other you may wish to proceed to the next tutorial.



## 4.2 Methanol Tutorial

### Experimental Procedure

A methanol injection run requires a higher level of precision operation of the VP-ITC instrument than a water-water run to obtain optimal results. The integrated heats of each injection should be linear with the probable exception of the first peak.

The recommended procedures for preparation of solutions, degassing, filling the cell and injection syringe, etc. have been discussed in the previous sections and the following tutorial assumes your familiarity with those procedures and completion of *Section 4.1 Water-water baselines*.

### Sample Preparation

- Fill the sample cell with degassed water.
- Prepare 20 ml of the degassed water in a test tube and add methanol (0.5 ml) to make a 2.5% methanol solution.
- Degas the methanol solution for 5 minutes while stirring.
- Load the methanol solution into the injection syringe of the pipette.

### Conducting the Experiment

- Load the run parameters from the methanol.inj file.
- Enter a filename. (the name should have no spaces, periods or hyphens and should be less than 16 characters long).
- Execute the run and allow the system to complete the experiment.

### Analyzing the Data

- Minimize the VPViewer application by clicking on the **Minimize** button in the upper right corner of the window.
- Open Origin for data analysis, by selecting **Start**, from the Taskbar, then select **Programs:MicroCal Origin:MicroCal Inc. ITC**. You should see the ITC raw data template.

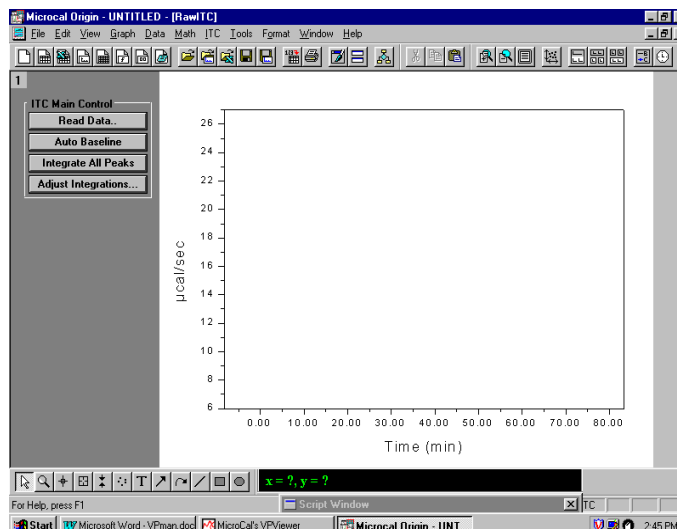



- Click on the **Read Data** button, to import your VP-ITC data into the plot window. Find your way to the data folder and select the file containing your experimental methanol data, (for this example we will use an example file named methanol.itc, your data folder contains a slightly different data file named methanol.itc with methanol data collected using your instrument, but you should be analyzing your experimental data) and click **Open**.

Origin will automatically plot the raw data, generate a baseline for the raw data, integrate all peaks, and display the integration results in the Delta H window. This data were generated at MicroCal on an VP-ITC instrument using 10ul injections of a 2.5% methanol solution. Your peak sizes may differ a little.

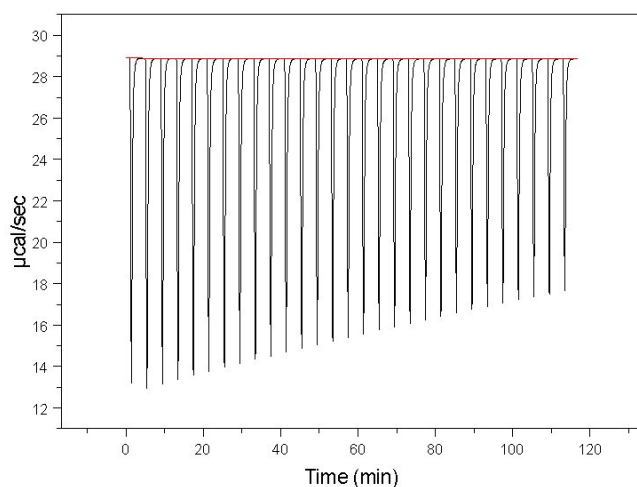

Raw ITC Data Window

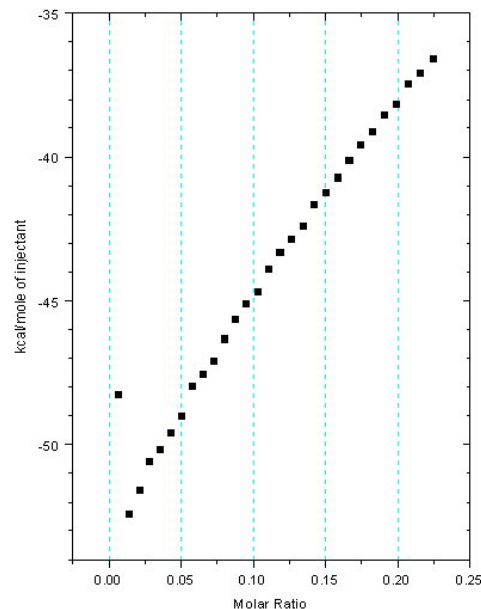

DeltaH Window

Origin automatically plots concentration-normalized areas (kcal per mole of injectant, designated with an .ndh extension) into the Delta H template whereas what we want to view is the raw data heats ( $\mu\text{cal}$  per injection, designated with a .dh extension).

- Double-click on the layer icon box (a gray box with '1' in it) located in the upper left to open the layer 1 dialogue box of the Delta H window.
- Move the methanol\_ndh file out of the Layer Contents (click on the name methanol\_ndh then click on the '<=' button) and move the methanol\_ndh file from Available Data to Layer Contents (click on methanol\_dh then click on the '=>' button), and click on OK.

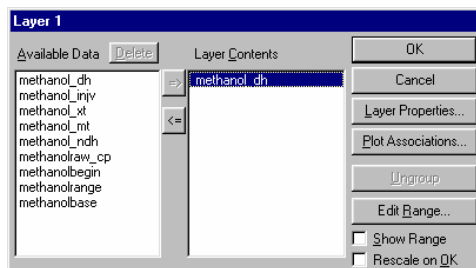

The new data set will be plotted as a line. You may change this plot symbol by right-clicking anywhere on the plot line and selecting **Change to Scatter** from the drop down menu list. Double-click on the numerical tick labels on the Y-axis, which causes the dialogue box for the Y-axis tick labels to appear. In the Factor box in the upper

right you will notice a Divide by Factor of 1000 (which is normally used to convert from cal to kcal). Edit to put a 1 in the factor text box, rather than 1000, and click OK.

Now the data set is plotted in terms of  $\mu\text{cal}$  on the Y-axis versus a number proportional to injection number on the X-axis. You may compare your results with those shown here. The scatter of your points from a straight line should not be much worse than these. (You may obtain a linear regression fit of your data by selecting **Math : Linear Regression** from Origin's main menu bar). If you have already been through the tutorial guide for ITC Data Analysis in Origin, then you may wish to integrate all of your peaks one-by-one, rather than rely on the automatic integration procedure, and this will probably reduce scatter.

Again, as a gauge of your success you may compare your results to the plot shown. While the methanol dilution experiment, in general, is not a test of the instrument's y-axis calibration (due to differences in methanol concentrations as well as the volatility of methanol itself), one can expect to receive similar heats. Most important is the linearity of the peak heights and areas.

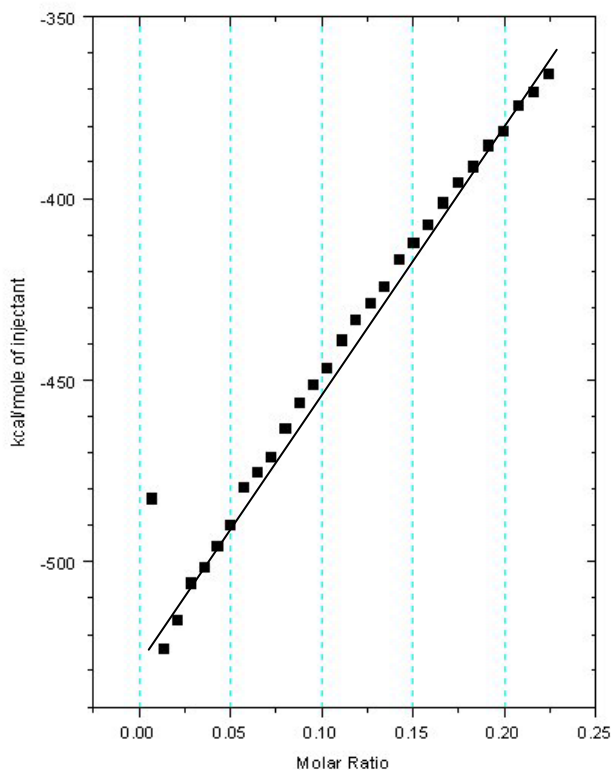

## Conclusion

If the data you obtained using 2.5% methanol looks considerably worse than the sample data we have provided for comparison, then you should go back to the beginning of this tutorial and repeat it. Perhaps you might want to read the Troubleshooting section first.

If you are satisfied with your methanol dilution data, then you may want to move on to real binding experiments.

### 4.3 Rnase-2'CMP Experiment Tutorial

Included with your instrument shipment, you should have received a test kit which includes solutions of buffer, the ligand 2'CMP and the enzyme Ribonuclease A. If you have not received this please contact [info@microcalorimetry.com](mailto:info@microcalorimetry.com) with shipping information and the sample will be sent to you. Before your instrument was shipped from MicroCal, we used aliquots of the same samples to generate a binding isotherm and have provided you with a copy of the results we obtained, including the run parameters and the fitting parameters obtained from data analysis in Origin. If your techniques are good, you should be able now to generate the RNase/2'CMP binding isotherm and obtain fitting parameters very similar to those obtained at MicroCal with your instrument.

The run parameters used in this experiment will be obtained from the *rnase.inj* run parameters file. This experiment should follow all recommended system preparation, sample preparation, loading and related operational standards outlined previously in this manual.

You should expect your results to be close to the data set sent with the samples. The following percentage error data would be considered acceptable for a new user.

N (Stoichiometry)	±5%
Kb (binding Constant)	±15%
ΔH (Enthalpy Change)	±5%

If everything has gone well to this point, then you should be ready to begin studies on your own samples. Good luck!!

## Section 5: Instrument Maintenance

The maintenance requirements of the VP-ITC are simple, but essential for quality experiments.

- The cells, injection and filling syringes must be kept clean.
- The Plunger Tips for the Pipette Injection Syringe must be replaced regularly to prevent excess wear that would allow the titrant to leak from the syringe.
- Y-axis calibration is usually not a problem, but it is good practice to confirm the calibration every 3 months.
- The Injection Syringe needle must be straight.
- The Plunger Screw must be kept straight.
- The syringe height (i.e. position of the stir paddle from the bottom of the cell) should be approximately 3 mm. Once the syringe height adjustment is set, it is not usually a problem, but this distance is custom for each instrument. This means that the user must set the height position of newly purchased replacement syringes.

This section is arranged as follows:

<b>Section 5: Instrument Maintenance .....</b>	<b>64</b>
5.1 Cleaning The Cells and Pipette .....	65
5.2 Replacing Pipette Plunger Tips .....	68
5.3 Y-axis Calibration .....	72
5.4 Replacing Injection Syringes & Height Adjustment .....	74
5.5 Temperature Calibration.....	75

## 5.1 Cleaning The Cells and Pipette

### *Cleaning Overview*

The VP-ITC uses fixed in place cells in order to provide maximum sensitivity and stability. These cells must be cleaned routinely to maintain the high performance of the instrument. Dirty cells will contribute greatly to cell filling problems, repeatability problems and possibly misinterpretation of data. Inadequate cleaning is the cause of **most** problems experienced with the VP ITC. **The importance of adequate cleaning cannot be stressed enough!**

The cleanliness of the syringes must not be overlooked. This includes the injection and filling syringes. These syringes are cleaned with the same cleaning solutions used for the cells. Be careful not to expose the syringes to extreme temperature changes as the thermal shock could break the glass.

### *Cleaning The Cells*

There are three methods of cleaning the cells. The simplest is manually rinsing the cells with buffer solution using the filling syringe. The second method involves using the cleaning device and is detailed in *Section 3.7 Using the ThermoVac for Cleaning the ITC Sample Cell*. The third method involves filling the cells with a cleaning solution and allowing them to soak at an elevated temperature. The first two methods involve some physical agitation, which is necessary to adequately clean the cells. The soaking method generally uses an aggressive cleaning agent after the others have failed. Rinsing with water after using any cleaning agent is important.

### **!** WARNING:

The cells of the VP-ITC are fabricated from Hastelloy C-276, and should **never be cleaned with strong acids** of any kind. Please consult the booklet provided on corrosion resistance of Hastelloy C-276 before using any substances that have corrosive properties.

### *Reference Cell Cleaning*

The VP-ITC reference cell doesn't require special cleaning but should be rinsed every week or two using the long needle syringes.

### *Routine Sample Cell Cleaning*

The VP-ITC sample cell need not be cleaned with detergent solution after each experiment, since rinsing with water or buffer from a syringe is often adequate. However, after every 3-5 experiments (or at the end of each day's experiments) solids that cannot be removed by rinsing may adhere to the cell interior and these can cause baseline problems if not removed periodically by a thorough cleaning with detergent solution.

For routine cleaning prepare a 5% solution (v/v % with distilled or deionized water) of Contrad-70<sup>1</sup> at room temperature. Using the glass needle cell filling syringe enter the solution into the sample cell and allow to sit for 10-15 minutes.

---

<sup>1</sup> Contrad-70 (referred to as Decon-90 in Europe), manufactured by Decon laboratories, contains dodecylbenzenesulfonic acid, potassium hydroxide, sodium citrate and sodium laurel ether sulfate.

Sources: Decon Laboratories, Bryn Mawr, PA 19010 USA - 1.610.520.0610 – Decon Catalog # 1003

Thomas Scientific, P.O. Box 99, Swedesboro, NJ 08085-0099 - 1.609.467.2000 -Thomas Cat. #2901-C30

**!** **CAUTION-Contrad-70 is highly caustic and a severe eye irritant; use latex gloves and safety glasses; make sure the cells are at room temperature or below before adding or removing Contrad-70; follow the manufacturer's instructions on the container.**

Cool the cells to room temperature then remove and dispose of the Contrad-70. A thorough rinse with distilled or deionized water should follow.

We do not recommend drying the cell before filling with your sample solution, but it should be rinsed twice with the buffer you are using for the experiment. Finally, it should be completely drained and filled with your sample solution in the manner described earlier.

A small amount of the buffer used for final rinsing will adhere to the walls of the cell and act to dilute your sample solution, if you measured the concentration before the sample was introduced into the cell, you may wish to correct for this by lowering your sample concentration by 2%.

### ***Vigorous ITC Cell Cleaning Method***

Occasionally, calorimeter cells will require a more vigorous cleaning method to provide maximum sensitivity and high performance.

When the cells are at room temperature or below, fill the cells with a 10% solution of Contrad-70, raise the temperature to 65°C and let stand for one hour. **CAUTION-Contrad-70 is highly caustic and a severe eye irritant; use latex gloves and safety glasses; make sure the cells are at room temperature or below before adding or removing Contrad-70; follow the manufacturer's instructions on the container.** Cool the cells to room temperature then remove and dispose of the Contrad-70. A thorough rinse with distilled water should follow.

### ***Cleaning Recommendations***

As a general rule, the simplest effective method of cleaning is generally preferred. Short of a very aggressive method it is impossible to give a global recommendation for all samples. Therefore the following suggests simple to the more aggressive methods. Please note this list is not all inclusive and many variations exist.

The selection of a cleaning agent is crucial. All of the components of the sample to be cleaned need to be soluble in your cleaning solution. The cells of the VP ITC are constructed of a Hastelloy<sup>®</sup> alloy. This alloy is highly resistant to basic solutions and partially resistant to acidic solutions. With this in mind it is generally best to use a basic or neutral cleaning solution on a regular basis and revert to an acidic solution only when absolutely necessary and only under MicroCal's specific recommendation.

**Buffer Rinse:** The cell(s) are rinsed three or more times with the full volume of a filling syringe containing buffer. Generally each syringe full is repeatedly oscillated in and out of the cell before being discarded. If more experimentation will be conducted with the same buffer, then the cell is simply drained from the bottom and a new sample introduced. When a new buffer is to be used, the cell is rinsed with water and drained, and the cell rinsed with the new buffer.

**Detergent Rinse:** The cell(s) are rinsed three or more times with the full volume of a filling syringe containing a detergent. A good general purpose cleaner is a 10% to 25% V/V aqueous Top Job™ solution at ≥50°C (use plastic syringes when working with hot solutions as glass syringes may fracture). The temperature is important as the effectiveness drops greatly as the

temperature drops. Top Job is a general purpose ammoniated household cleaner consisting of ionic and non-ionic surfactants. The cells are then extensively rinsed and drained.

**Detergent Wash:** The cleaning device is used as described in *Section 3.7 Using the ThermoVac for Cleaning the ITC Sample Cell* (page 47). 200-400 ml or more of detergent solution is passed through the cells. 300 ml or more of water is then passed through the cells to rinse the detergent out.

**Detergent Soak:** The cells are filled with a detergent solution such a 5% V/V aqueous Contrad-70™ solution. The cells are not capped but covered with a damp paper towel. The thermostat temperature is then set to 65°C for one hour. The cells are then cooled and rinsed with 300 ml or more of water using the cleaning device. Do not exceed one hour unless advised by a MicroCal engineer to do so.

**Base Soak:** This is an extreme measure and should only be preformed after consulting with a MicroCal engineer or representative and should not be preformed on a regular basis. The cells are filled with a 12% solution of sodium hydroxide. The cell is covered with a damp paper towel placed over the cell port. The system is then thermostatted at 65°C. for one hour. The system is then cooled and rinsed with water using the cleaning device.

## ***Cleaning Agents***

Your choice of cleaning agents will vary with the cell contamination. Below is a partial list of several agents and their applicability.

**Top Job (Mr. Clean):** Is manufactured by Procter and Gamble and is available in many supermarkets.

**Dawn Dishwashing Detergent.** Also Manufactured by Procter and Gamble and is available in many supermarkets. It is used as a mild protein cleaner.

**Contrad-70:** An excellent biological cleaner for a wide variety of contaminations. It is biodegradable and easily rinsed. This solution is an excellent agent for the VP ITC

**Pepsin (.1% solution):** Used as a soaking agent to digest difficult protein problems.

**EDTA (10% solution):** Used as a post cleaning rinsing agent to eliminate metal ion contamination.

**Organic Solvents:** Methanol, hexane, toluene and other solvents are used to remove lipid and some polymer contamination.

## **A Word of Caution**

Careful consideration should be put into the selection of a cleaning program. As mentioned previously the cells of the VP ITC are constructed of Hastelloy. Hastelloy is highly resistant to attack from bases but not from acids. Care should be exercised to avoid damage to the cells.

If the reservoir should overflow during your cleaning procedure, the fluid may contaminate the stir motor bearing and damage it beyond repair. This must be avoided! If an overflow does occur, the injector should be removed and the bearings on the underside should be wiped dry. If internal contamination is suspected, you should consult with a MicroCal engineer for assistance.

## 5.2 Replacing Pipette Plunger Tips

It is recommended that when using the VP-ITC instrument on a daily basis, that the plunger tips of the pipette be replaced approximately once every month or two. The tools for replacing syringe plunger tips for the pipette injector consist of :

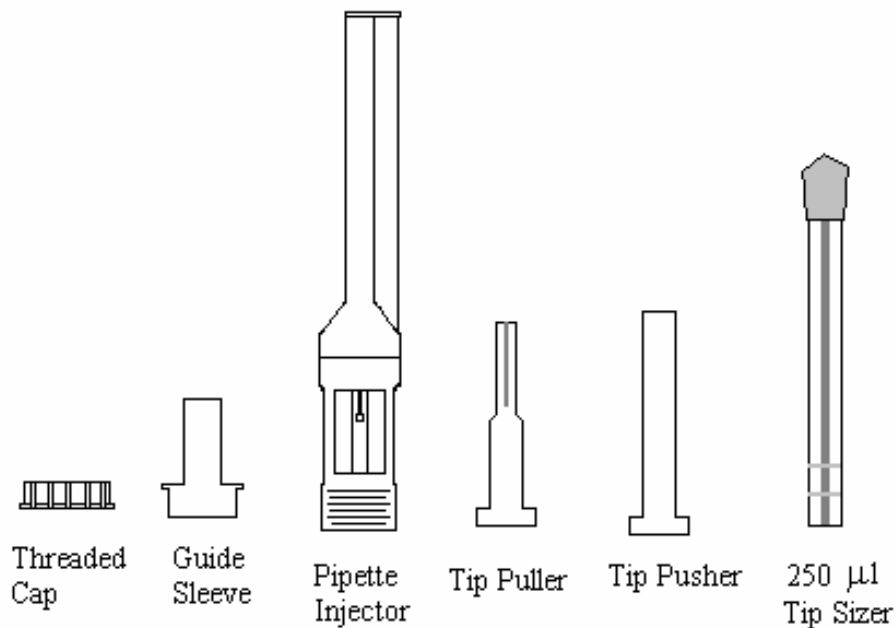

### ***Removing old syringe plunger tip from pipette injector***

You must first separate the Syringe Holder from the pipette injector.

- Place the pipette in its stand on the side of the instrument.
- Open the Setup/Maintenance menu.
- From the pipette maintenance group click on the **Remove Old Tip** button.

Wait for the injector plunger to move up to its replacement position (or home position), you will hear a beep when the movement is complete.

- Separate the injector from the Syringe Holder by turning the Locking Collar counter clock-wise.

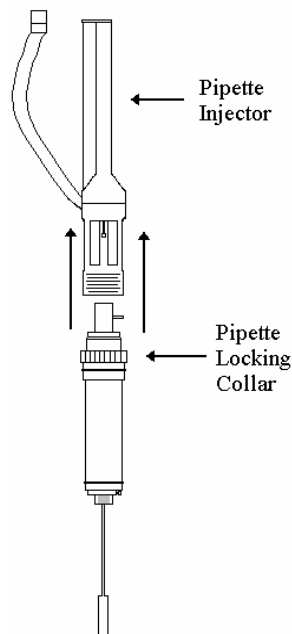



- Insert the **Guide Sleeve** into the Pipette Injector.
- Thread on the Threaded Cap, to lock the Guide Sleeve in place.
- ! **Never replace or polish plunger tips without the Guide Sleeve and Threaded Cap in place.**

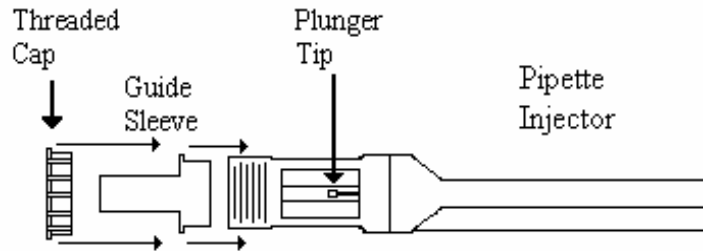

- Insert the **Tip Puller Tool** through the center of the Guide Sleeve and over the plunger tip.

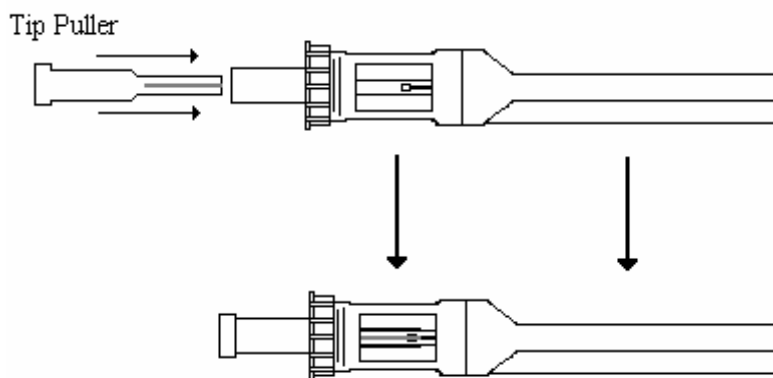

- To remove the tip, pull the **Tip Puller**, collinearly with the pipette screw, out through the Guide Sleeve. Occasionally, the **Tip Puller Tool** will fail to successfully grab and remove the tip. In this case the operator should move the plunger a little bit lower (ca 0.1" - 0.2") and try again. The plunger can easily be lowered through the Dn (down) Distance button in the Pipette Controls group of the ITC Controls window.
- ! **Do not apply an angled or perpendicular force to the Tip Puller, as this may bend the pipette screw and make the pipette unusable.**



To replace the tip, leave the Guide Sleeve and Threaded Cap on the Pipette Injector and proceed.

### ***Inserting the new syringe plunger tip***

To insert the new tip:

- The **Guide Sleeve** and **Adjustment Collar** must be in place as described on the previous page.
- Select the **Install New Tip** button
- Place a new plunger tip (open end of plunger tip facing out) into the end of the **Tip Pusher Tool**.
- Insert the **Tip Pusher Tool** through the center of the **Guide Sleeve** and over the end of the plunger.

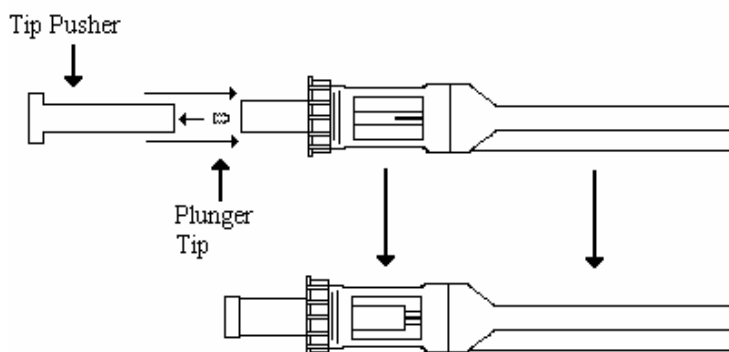

- Pull out the Tip Pusher Tool to remove the Plunger Tip.

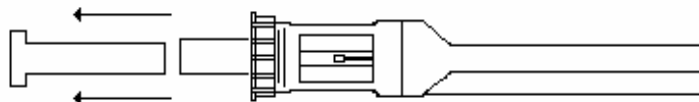

Leave the Threaded Cap and Guide Sleeve on the Pipette Injector to prepare for tip polishing.

### Polishing a new plunger tip

After replacing a tip it will need to be polished to remove any high spots that may exist on the Teflon plunger, due to the manufacturing process. To polish a new tip:

- Ensure that the Guide Sleeve and Threaded Cap are in place.
- Click on the **Polish New Tip** button. The injector screw should extend out ca. 1½ inch (ca. 40 mm) and be hidden by the Guide Sleeve. Carefully push the glass bore Polishing Tool over the new plunger tip. **Please note: the 250 µl glass bore Tip Sizer tool must align with the pipette screw; the barrel must not be inserted at an angle as this may cause the injector screw to bend.**

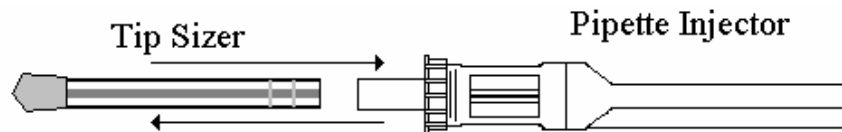

- Slowly and gently push the Tip Sizer tool back and forth over the new tip 10 to 20 times (using care to keep the polishing aligned with the injector screw of the pipette). As the tip is polished, it will travel in the glass bore more freely and less force will be required to ‘break it in’. A total of 30 to 50 strokes are usually required.
- When you are finished remove the Tip Sizer tool.
- Unscrew the Threaded cap and remove the Guide Sleeve.

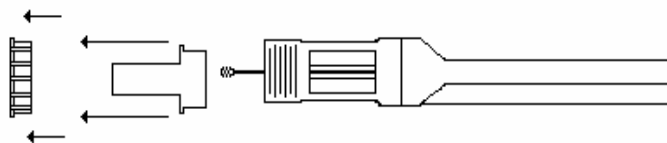

- Using cotton tipped applicators (dipped in methanol), small tweezers, lint free paper towels and/or clean compressed air (or other clean gas), clean the plunger tip carefully to remove any Teflon shavings, dirt or other fibers from the plunger tip.

**! Caution: inspect the tip carefully to insure no extraneous fibers or dirt is attached to the plunger tip before proceeding.**

- Click on the **New Tip Polished** button. The injector screw will retract into the pipette.
- While observing that the plunger tip is aligned with the bore of the injector syringe, turn the Locking Collar to screw the Pipette injector to the base to reassemble the pipette.

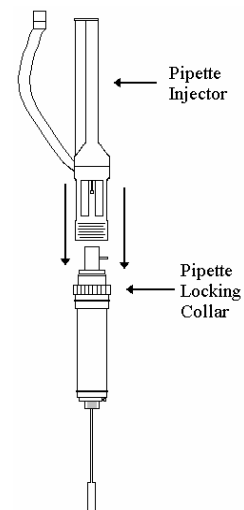

## 5.3 Y-axis Calibration

All necessary calibrations of your VP-ITC are carried out at MicroCal prior to shipment. Still, it is a good idea that the user performs a y-axis calibration check every 2-3 months. Y-axis calibration is achieved by dissipating a known power through a resistive heater located on the cell wall, and by then adjusting the software coefficient for DP. When setting up an ITC calibration experiment, it is best to enter calibration heat **Pulse Sizes** (power is in uCal/sec.) on the order of 1 uCal/sec. or larger, in order to negate any effects from baseline drift. Users must enter **Pulse Durations** for at least 4 minutes to allow enough time to establish a flat deflected baseline. Finally, users will want to allow enough time after the heat pulse has been turned off to allow the DP to return to its original baseline position. Entering a value for **Pulse Spacing** which is at least 4 minutes longer than the Pulse Duration will allow the deflected baseline to return to its original value. Users are encouraged to use the default parameters for y-axis calibration runs. The following procedure uses the default parameters.

To initiate a y-axis calibration procedure select ITC/Start ITC Calibration Run/Y Axis.



Once the menu has been selected, the Calibration Pulse Setup Window will appear. This window will serve as the pulse parameter editing window where users will define the calibration pulses to be entered. Individual pulse parameters are entered by first selecting a pulse or multiple pulses, then entering the desired parameter value into the pulse parameter boxes (Calibration Power, Pulse Duration and Pulse spacing). This window is pictured below:

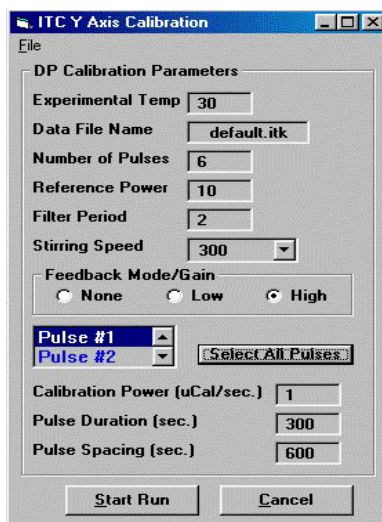

The parameters shown in the above window will allow for setting of all relevant y-axis calibration parameters with the exception of the delay period prior to the first pulse. This variable

comes from the Standard ITC setup menu as the Initial Delay value. This value should be at least 60 seconds.

Users are encouraged to simply use the default y-axis calibration parameters. After the run and pulse parameters are entered, clicking on the Start Run button will start the run. The ITC will equilibrate in the same manner as it would during a titration experiment.

After the final equilibration phase has completed, the initial delay will begin and the pulses will be applied as entered. As each pulse completes, VPViewer will analyze the pulse region and determine the deflection of the baseline as well as the energy (area) of the pulse. The requested power and energy will also be displayed as will a percent error for both power and energy. It is sufficient for users to gauge the accuracy of their y-axis calibration by the results supplied by VPViewer, in the script window. An example of these results, is shown below:

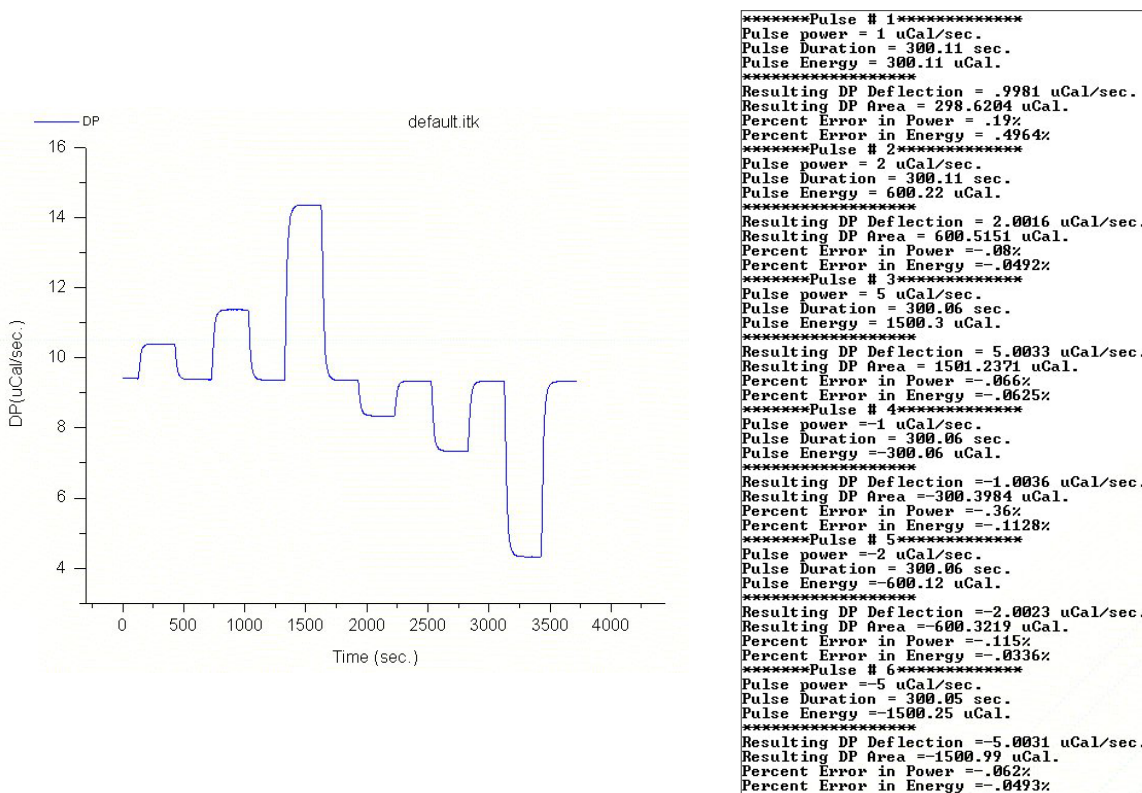

In general, users can anticipate that the reported error in deflection or energy will be less than 1%. If the error is reported as higher than 1%, please call MicroCal and speak to a Service Representative. If a more thorough analysis of y-axis calibration results is desired, the calibration data file can be read into Origin just as a titration data file can for detailed analysis.

Also, it is important that users realize that the data displayed in VPViewer, in real time, will change in its appearance after each pulse analysis is carried out. After each pulse is turned off and the DP signal has re-equilibrated to its original baseline, the data is operated on within VPViewer. The pulse region will have a linear baseline subtracted from it resulting in the baseline portion of the pulse region to be offset very close to zero. After this subtraction it is easy to gauge the actual deflection of the pulses from the graph. Also, it need be mentioned that only the data within VPViewer will be operated on in this way and that the \*.itk data file will contain only raw data.

## 5.4 Replacing Injection Syringes & Height Adjustment

If you order a replacement syringe for the pipette you will need to adjust syringe height (i.e. the position the stirring paddle in relation to the bottom of the cell). Each titration syringe comes with a round 'height disk' (upper Syringe Clamp) that will ultimately determine your syringe height once the syringe and syringe holder is inserted into the ITC sample cell. Prior to using the new titration syringe in your ITC you will first need to properly set the 'syringe height'. The syringe height is the distance between the bottom of the syringe needle and the bottom of the cell, and is a critical setting for ITC performance. The proper setting for the ITC syringe height is 3 mm off the bottom of the cell. To make this adjustment, follow the steps outlined below:

### *Removing The Old Syringe From The Pipette Injector*

You must first separate the Syringe Holder from the pipette injector.

1. **Place the pipette in its stand** on the side of the instrument.
2. **Open the Setup/Maintenance menu.**
3. From the pipette maintenance group **click on the Remove Old Tip** button.

Wait for the injector plunger to move up to its home position, you will hear a beep when the movement is complete.

4. **Separate the injector from the holder** by turning the Locking Collar counter clock-wise.
5. **Remove the lower Syringe Clamp** using a .050" Ball Point Hex Driver.
6. **Remove the old syringe** by using a collinear force (to prevent the syringe needle from bending) with the Syringe Holder.

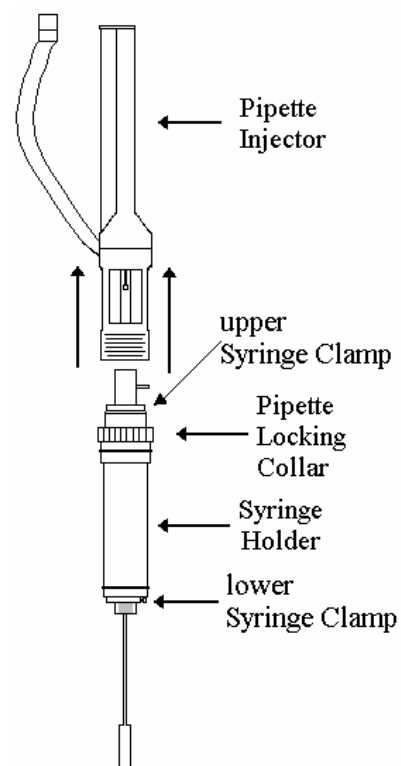

### *Setting The New ITC Syringe Height*

7. **Loosen the set-screw** on the upper Syringe Clamp so that the disk is free to slide up and down on the outer diameter of the syringe glass.
8. **Position the syringe in the syringe holder** so that the tip of the syringe will not hit the bottom of the cell when the syringe/holder assembly is inserted into the sample cell. This can be easily accomplished by **positioning the glass of the syringe so that it is flush to the bottom of the holder, but not lower.**
9. Insert the syringe/holder assembly into the sample cell compartment and properly seat the assembly into place.
10. **Gently push down on the top of the syringe until you feel it hit the bottom of the cell.** If you are unsure then double-check it by lifting the syringe up and lowering it again until the bottom of the cell stops it.

11. **Lower the upper Syringe Clamp** so that it is flush to the top of the syringe holder.
12. **Tighten the set-screw** of the upper Syringe Clamp so that the disk is fixed to the syringe glass.
13. **Raise the syringe** by carefully prying up on the upper Syringe Clamp until it is **approximately 3 mm** higher than the top of the syringe holder.
14. **Loosen the set-screw** of the upper Syringe Clamp so that the clamp is free to slide up and down on the outer diameter of the glass bore. **Lower the Syringe Clamp** all the way down so that it is again flush to the top of the syringe holder.
15. **Tighten the set-screw** of the upper Syringe Clamp and your syringe height is now fixed at 3 mm from the bottom of the sample cell.

### ***Reassemble the Pipette***

Please refer to Section 1.6 Pipette Assembly (page 9), for instructions on how to reassemble the pipette with the new syringe

## **5.5 Temperature Calibration**

### ***ITC Temperature Calibration Kit Contents***

- Stainless Steel capillary temperature standards (Qty. 2).
- Origin 5.0 project, ITCCalibration.opj, used for convenient data interpretation and for generation of calibration reports.
- VPITC Temperature Calibration Instructions.

### ***ITC Temperature Calibration Procedure***

You have received temperature standards for use with your VP-ITC. This document will describe how a VP-ITC user can use the capillary temperature standards to periodically check the calibration of the temperature data channel of the VP-ITC. It is recommended that the ITC temperature calibration be checked approximately once every 12 months. The measured transition midpoints should be within +/- 0.2 degrees of the known transition midpoints (28.2, 75.9 degrees), or adjustments to the temperature calibration coefficients should be made.

Each of the 2 capillary temperature standards contains a wax with a known melting point. The shorter standard contains Octadecane ( $C_{18}H_{38}$ ), which has a known melting point of 28.2 degrees Celsius. The longer standard contains n-Hexatriacontane ( $C_{36}H_{74}$ ), which has a known melting point of 75.9 degrees Celsius. By heating these standards through their respective melting points while measuring the heat effect as a function of cell temperature, an ITC user can verify the proper calibration of the temperature measurement system of the VP-ITC. The procedure for performing a temperature calibration run, for analyzing the results, and for adjusting the calibration coefficients (when necessary) are described below:

## Running The ITC Temperature Standards

- 1.) Begin by emptying both the reference and sample cells, then refilling both with freshly degassed water. Fill both cells completely, then remove any excess solution from the overflow reservoirs. The titration syringe, syringe holder and pipette will not be used during a temperature calibration run, and may be left aside during the process.
- 2.) Insert the shorter, low temperature capillary standard into the sample cell and the longer, high temperature capillary standard into the reference cell. With the standards inserted like this, the low temperature transition peak will be in the positive direction, and the high temperature transition peak will be in the negative direction.
- 3.) From the VPViewer 2000 application, go to the ITC Controls window tab. Select the menu **Start ITC Calibration Run|Temperature Check**, as shown below:

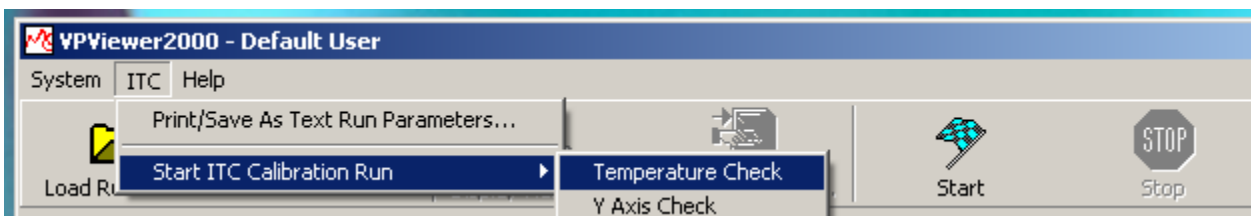

- 4.) VPViewer 2000 will perform the following steps in carrying out a temperature calibration run:
  - a.) Equilibrate the ITC cells and jacket at 22 degrees Celsius.
  - b.) Scan the cells and jacket, under adiabatic conditions, through the low temperature transition region while collecting and saving the resulting DP data. Resulting temperature calibration data will automatically be saved in the file tm<sub>low</sub>.dat.
  - c.) Rapidly heat the ITC jacket and cells to high temperature without equilibrating the jacket and cells.
  - d.) Equilibrate the ITC cells and jacket at 73 degrees Celsius.
  - e.) Scan the cells and jacket, under adiabatic conditions, through the high temperature transition region while collecting and saving the resulting DP data. Resulting temperature calibration data will automatically be saved in the file tm<sub>high</sub>.dat.

## Analyzing Your Results

- 5.) Users can then generate a temperature calibration report using a pre-programmed Origin project, provided with the ITC temperature standards. Open the Origin 5.0 application and switch to the Short Menu Level. This is done using the **Format|Menu|Short Menus** menu selection within Origin. Next, open the c:\vpitc\data\ITCCalibration.opj Origin project. The project will appear as pictured below:



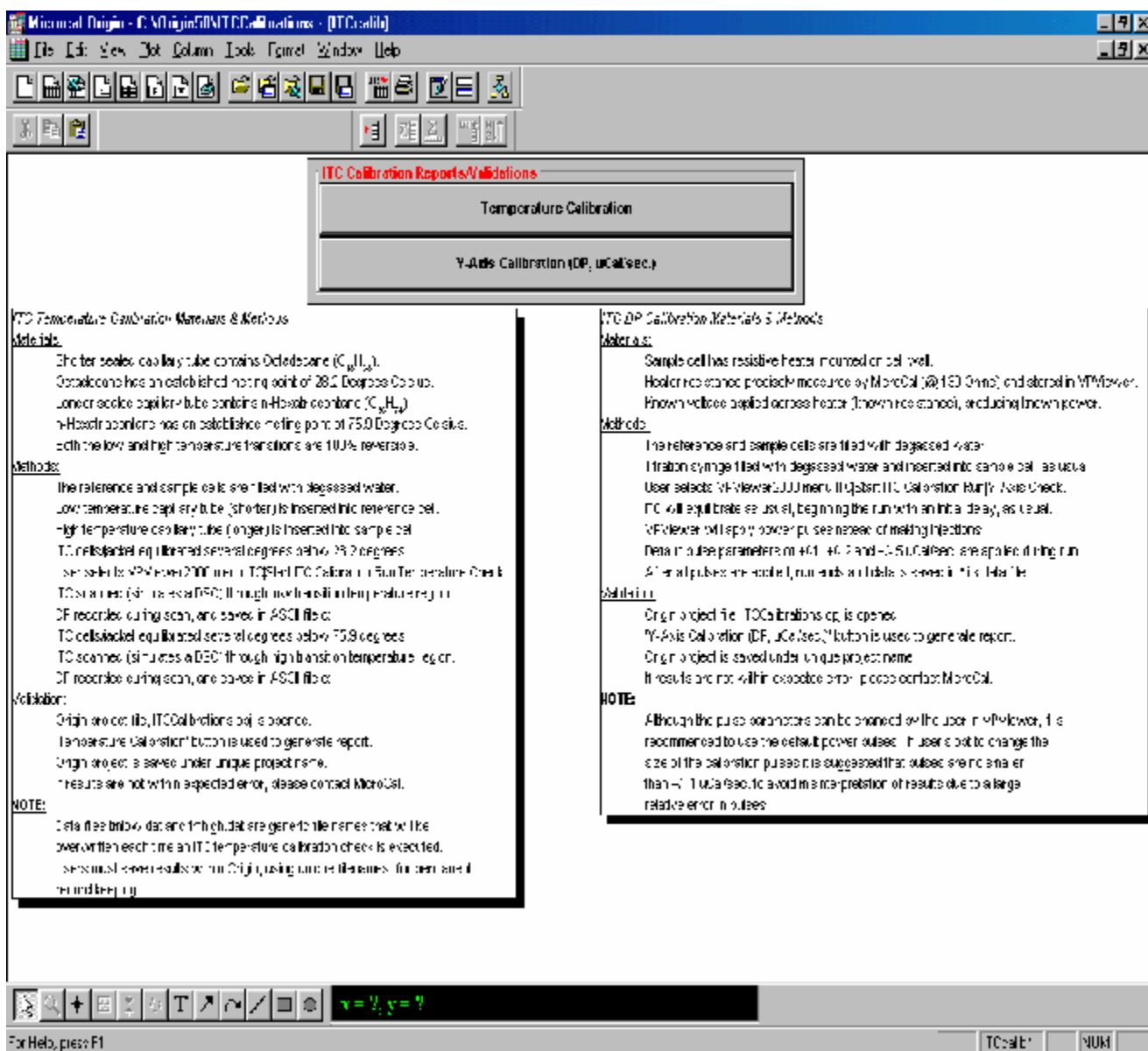

- 6.) Click on the button **Temperature Calibration** the two files will be read into Origin for automatic analysis. The results for the low and high temperature transitions will be plotted and displayed separately, and the measured transition midpoints will be displayed on the appropriate graphs. Your graphs will appear similar to those pictured immediately below:

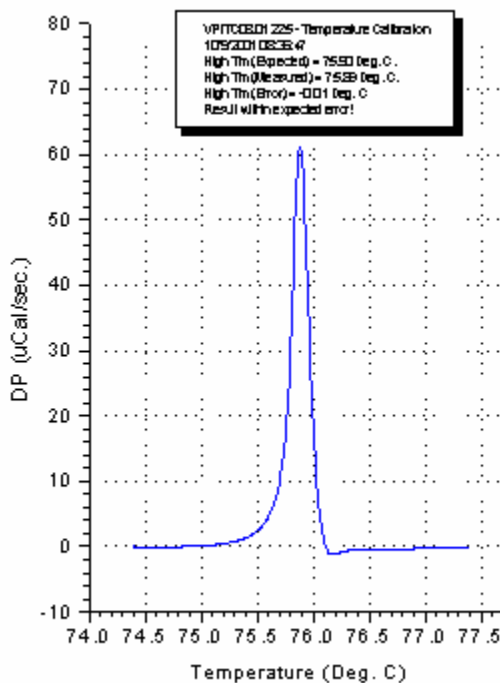
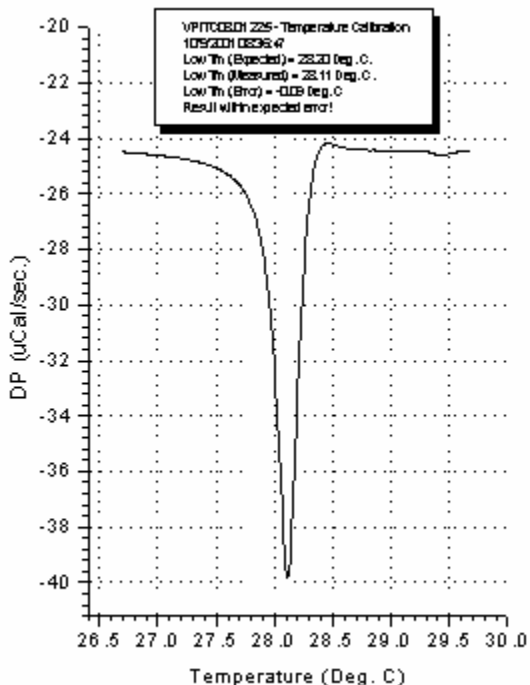

**NOTE: In viewing your ITC temperature calibration results, you should also be inspecting the results for reasonableness. Users will be responsible for erroneous changes being made to the temperature calibration coefficients, and it should be avoided. Any changes made to the temperature calibration coefficients will only be appropriate if correct measured transition midpoints are used in making those changes. If, for any reason, a user suspects that incorrect measured transition midpoints will be used, please consult MicroCal for assistance.**

7.) It is suggested that each VP-ITC temperature calibration report be saved as a unique Origin project file. Since each instance of VP-ITC temperature calibration results will save the resulting raw data under a generic filename (tmlow.dat and tmhigh.dat), permanent calibration record keeping can be accomplished by saving the Origin project under a unique name, each time. Users will be prompted to save the Origin project each time an ITC temperature calibration report is generated.

## Adjusting The ITC Temperature Calibration

If the measured transition midpoints are not within +/- 0.2 degrees of the expected results, then adjustments to your temperature calibration coefficients should be made. VPViewer 2000 should be used to change the coefficients based on your recent results. To adjust your temperature calibration coefficients within VPViewer, carry out the following steps:

- 8.) From within the VPViewer 2000 application, select the **Constants** window tab. All calibration constants for your VP-ITC will be displayed. Additionally, there will be 3 buttons on the right edge of the Constants Window, as pictured below:

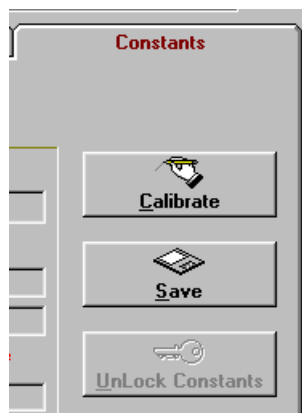

- 9.) The constants window is disabled, by default. To enable the window and allow for changes to be made, click on the **UnLock Constants** button. Enter xxx into the password box and click on OK. The window is no longer locked and changes will be allowed.
- 10.) Click on the **Calibrate** button and a new window will appear. The present temperature calibration coefficients will appear, as well as the expected values for the two transitions of the capillary standards. Enter the actual measured transition midpoints, as reported by Origin, into the provided boxes. Your window will appear similar to the picture below:

Current Temperature Constants			
Temp Read Slope	<input type="text" value="100"/>	Temp Read Offset	<input type="text" value="0"/>
Temp Set Slope	<input type="text" value=".052986"/>	Temp Set Offset	<input type="text" value=".045406"/>
Temperature Read Calibration Results			
Low Tm should be	<input type="text" value="28.2"/>	*C.	Data file result is <input type="text" value="28.05"/>
			*C.
High Tm should be	<input type="text" value="75.9"/>	*C.	Data file result is <input type="text" value="75.75"/>
			*C.
Calculated Temperature Constants			
Temp Read Slope	<input type="text"/>	Temp Read Offset	<input type="text"/>

- 11.) Click on the **New Coefficients** button, and VPViewer 2000 will calculate, display and save the new calibration coefficients based on your recent results.

## Section 6: Tips and Troubleshooting

This section provides tips for optimizing the performance of the ITC instrument and troubleshooting techniques for commonly encountered problems. After a new user has gained a working knowledge of the instrument and software, it is strongly urged for the user to read through this section in its entirety before proceeding with experiments involving precious samples.

Please refer to our web site at [www.microcalorimetry.com](http://www.microcalorimetry.com) for updated tips, troubleshooting and application notes.

This section is arranged as follows:

<b>Section 6: Tips and Troubleshooting .....</b>	<b>80</b>
6.1 User Tips and FAQs .....	81
6.2 Troubleshooting.....	82
6.3 A Note About Buffers .....	83
6.4 Selecting the Proper Stirring Rate .....	83
6.5 Estimation of Required Concentrations.....	84

## 6.1 User Tips and FAQs

- 1.) When powering up the VP-ITC, always follow the sequence listed below:
  1. Turn on PC power
  2. Turn on VP-ITC power
  3. Launch VPViewer
- 2.) After initial power up of the VP-ITC, the data channels will display incorrect values until the power LED on the front of the cell unit becomes lit. Once the power indicator light comes on, all data channel readings will be accurate and the instrument is ready to use.
- 3.) When the VP-ITC requires cooling to get to a target temperature (thermostat or run temperature) it uses an algorithm which will do the following:
  - Set shield to target minus 10 degrees to help cool jacket/cells via conduction/convection.
  - Wait for jacket temperature to be cooler than target minus five degrees.
  - Set shield to target minus three degrees to bring jacket and cells closer in temperature.
  - Wait for deltaT to be non-saturated (small jacket-cell deltaT).
  - Set shield to target minus one degree.
  - Heat cells and jacket to target

While this algorithm requires more time than heating, it will cool the VP-ITC to the desired temperature as fast as possible and the operator should not interrupt the algorithm in efforts to speed up the cooling process. For very low temperature operation of the VP-ITC (less than 10 degrees), users should call MicroCal for consultation.
- 4.) When filling the cells it is important to load solution that is colder than the intended run temperature. The operator must also account for the change in temperature that will occur during the transfer of solution to the filling syringe and then into the cells. If a solution which is hotter than the ensuing run temperature is loaded into the cells, the ITC will likely require cooling in order to get a precise starting temperature for the run. Alternatively, the operator could check the 'No Check T' option in the ITC setup window. This will tell VPViewer to allow the jacket to be heated up to the cell temperature and commence with the pre-run equilibration.
- 5.) When filling the injection syringe, there are a couple of things that should be avoided in order to get the optimum performance from the ITC.
  - Do not allow the syringe needle or paddle to be flexed when drawing solution into the syringe during filling. During syringe loading this can sometimes occur if the sample tube is not straight in the threaded tube holder, or if the threads themselves were not mated correctly. If you can see that the needle or paddle is hitting the side or bottom of the sample tube, correct the situation before you actually draw your solution into the syringe.
  - Do not allow the solution level to go below the bottom tip of the paddle when drawing your titrant into the syringe. Be sure to close off the flow path (close port button) before the solution level gets too low. The sample tube can be positioned in its holder to adjust its height relative to the bottom of the paddle if necessary.
  - Always avoid flexing of the injection syringe needle when inserting and removing it from the cell.

## 6.2 Troubleshooting

### **PROBLEM: Long equilibration period before an experiment starts.**

There is no capability for directly cooling the cells nor the inner jacket of the VP-ITC, as was also the case for our earlier ITC instruments. If the operator is carrying out a series of experiments in the VP-ITC at 25.0 °C, for example, and if the freshly loaded sample solution has a temperature of 26.0 °C, then there are but two choices. If the *No Check T* option in the set-up window is checked X and the experiment started, then the system will equilibrate quickly at 26.0 °C. If the *No Check T* option is unchecked then the software begins a process to cool the cells. This process consists of first lowering the temperature of the outer shield (which has cooling capability) far below 25 °C which in time acts to lower the temperature of the inner jacket and ultimately the cells, both of which must cool by heat transfer to the outer shield. After the cells and inner jacket have cooled to 25 °C, the temperature of the outer shield is cycled back up to its set position to begin the experiment. Because heat exchange with the outer shield is slow, this process can take a significant amount of time, even when the cell temperature only needs to be decreased by a degree or so.

### **AVOIDING THE PROBLEM:**

To avoid the lengthy delay in cooling the cells and still be able to operate at the desired temperature, the operator need only control the temperature of the solution to be loaded, such that the final temperature of the cell, after loading, is at or below the temperature where the experiment will be carried out. When this is the case, the *No Check T* option should be left unchecked and the cells will promptly be heated to the correct temperature (without changing the temperature of the outer shield) so that the experiment will be ready to begin in a short time. For experiments below room temperature, solutions should initially be cooled (after degassing) significantly below the set temperature since they will warm up somewhat when drawn into the loading syringe and transferred into the cell.

### **PROBLEM: Baseline is stable without stirring, but becomes unstable after syringe is inserted and stirring begins prior to injections.**

#### **SOLUTION:**

Indicates a stirring problem. May be debris or bubbles in cell, bent injection syringe needle, improper syringe height adjustment, or injection system alignment problem.

**Debris or bubbles** – refill cell after rinsing or using cell cleaning apparatus and try again. Extraordinary circumstances may require carefully inverting the entire VP-ITC unit on a suitable stand and flushing the sample cell with the filling syringe to remove solid debris.

If your test samples are suspensions of particles try higher stirring rate to achieve uniform suspension, although the extra noise caused by the increased stirring speed may cause deterioration of the baseline.

**Bent injection syringe needle** – Remove the syringe from the pipette and roll on flat tabletop. Watch the needle to see if there is any wobble, indicating it is not straight. A machinist using a lathe can sometimes straighten bent needles.

**Syringe height adjustment** – The syringe height adjustment (distance from the bottom of the cell to the bottom of the syringe stirring paddle) is important for optimizing the performance of your ITC. This distance has been found to be approximately 3 mm. Once this adjustment has been set it is usually good for the life of the syringe, but new syringes must be set according to section

**PROBLEM:** The baseline seems to drift over time and appears cyclic.

**SOLUTION:**

Check to see if the ITC cell is in the direct path of a heating/cooling vent. If so, relocate the ITC away from air currents or direct the air currents away from the ITC. Also, the baseline may drift more than desired if the room in which it sits is not stable in temperature. Try to provide the ITC with a well thermostatted environment.

**PROBLEM:** When attempting to remove a pipette plunger tip, the tip removal tool is unable to grab the tip, with the tool slipping off the tip instead.

**SOLUTION:**

To remedy this you must move the pipette plunger down slightly. One can use the Dn (down) Distance button in the Pipette Controls group of the ITC Controls window to move the plunger ca. 0.1” - 0.2” downwards. The tip removal tool will then be able grab the plunger tip.

## 6.3 A Note About Buffers

***DTT (Dithiothreitol)*** – If possible, DTT should not be used in the solution for ITC experiments. Since some proteins are unstable without DTT, the presence of DTT in solution should be as low as possible. Experimental data suggests that even 1 mM DTT could cause a large artifact in the ITC baselines. One way to minimize the artifacts is to remove oxygen from the solution by purging with argon (better) or nitrogen.

***TCEP ((tris(2-carboxyl)phosphine)*** – Experimental data suggests that TCEP at low concentration (i.e. 1 to 2 mM) have little effect on the ITC baselines, although at a higher concentration (i.e. 10 mM) it causes a large slope in the ITC baseline. For some proteins, it may be a good idea to replace DTT with TCEP, but the user is cautioned to be aware of potential problems.

## 6.4 Selecting the Proper Stirring Rate

There are 5 stirring rates available, they are approximately 0, 270, 310, 500 and 580 RPM (revolutions per minute). The exact stir rate for your instrument is measured and the value is entered into the software. In selecting the optimum rate, there is a trade-off between mixing efficiency and baseline noise. For almost all your studies, stirring rates of ca. 270-310 will give adequate mixing following injections and still provide very high baseline quality. However, for binding studies where the  $c$  value (i.e., the product of the binding constant times the concentration

of sites in the sample cell ) is in excess of 1000, you may obtain better values for the binding constant at 580 RPM. The reason for this is that when binding is extremely tight, a significant error is encountered near the equivalence point if the injected ligand solution does not mix completely throughout the entire volume of the sample cell. Finally, when you are studying particulate suspensions, which tend to settle from gravity, more stirring speed will be needed to provide the energy to keep a uniform suspension.

## 6.5 Estimation of Required Concentrations

A frequently asked question is "I'm not sure of my system's binding constant, what concentrations should I use?"

The following equation is a good approximation of the concentration of the material in the sample cell ( i.e. an enzyme ):

$$K_a * C = 10 \text{ to } 50$$

Where  $K_a$  is the binding (association) constant expressed as a positive power of 10 (i.e., 10) and  $C$  is the molar concentration of the binding component in the sample cell. If  $K_a$  is unknown, a best guess will have to suffice.

The molar concentration of the binding material in the syringe (i.e. an enzyme inhibitor) is estimated as follows:

$$100 \mu\text{l syringe: } 20 * n * C$$

$$250 \mu\text{l syringe: } 7 * n * C$$

Where " $n$ " is the Stoichiometry of the reaction and  $C$  is the molar concentration of the binding material in the sample cell.

These are "rules of thumb" and not absolute. However, if  $K_a$  and  $n$  are unknown, best guess and perhaps a range finding experiment should quickly allow the investigator to determine the correct experimental conditions.

As an example, assume we have an enzyme in the cell with a binding constant of 10. The concentration of enzyme should therefore be  $10 * C = 10$  to 50 or a concentration of between 10 to  $5 \times 10^{-10}$  molar. Assuming a Stoichiometry of 1, the concentration of inhibitor in the 100  $\mu\text{l}$  syringe should be 20-fold higher than the concentration of the enzyme in the cell ( $20 \times 1 \times 10$  or  $2 \times 10^{-10}$  molar, in the case of a 1  $\mu$  molar enzyme solution). If it were desirable to use the 250  $\mu\text{l}$  syringe, the concentration of inhibitor in this syringe should be 7 times the concentration of enzyme in the cell.



## Section 7: Additional Features

This section contains information that the user may find useful, but is not necessary for successful operation of the instrument.

This section is arranged as follows:

<b>Section 7: Additional Features</b> .....	85
7.1 Extended Data Display .....	86
7.2 Customizing VPViewer .....	86

## 7.1 Extended Data Display

In addition to the standard data channel display VPViewer can also display additional data channels used for troubleshooting. The extra data channels are displayed by double clicking on the numerical DeltaT display. These extra data channels are displayed below. (Double clicking on the Aux Chan(nel) label will toggle this display to a time display).

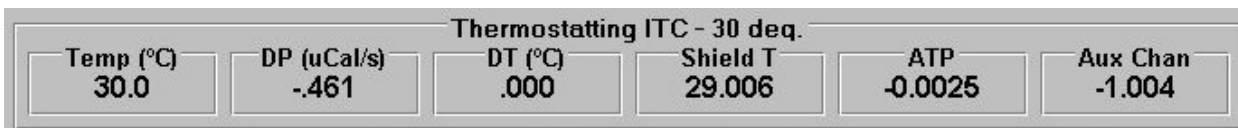

**Shield T (Deg/C)** This is the current temperature (in degrees Celsius) of the adiabatic shield.

**ATP(no units)** A numerical indication of heat sink operation.

**Aux Channel(no units)** A numerical indication of heat being applied to the jacket. If you double click on this numeric value the display will change to a time function

## 7.2 Customizing VPViewer

In instances of multiple users operating the same VP-ITC system, it may be advantageous for those users to be able customize some aspects of the VPViewer application and recall those custom settings. Specifying the desired VPViewer configuration file at start up can do this. If no configuration file is specified then the default configuration file will be used. The primary advantage to having multiple user profiles is that each user's data is saved to a separate folder (directory).

Within the *Setup/Maintenance* menu you will find the three buttons that will be used to initialize a new user. These buttons are *Save User*, *Add User* and *Erase User*. The window and corresponding buttons are displayed below.

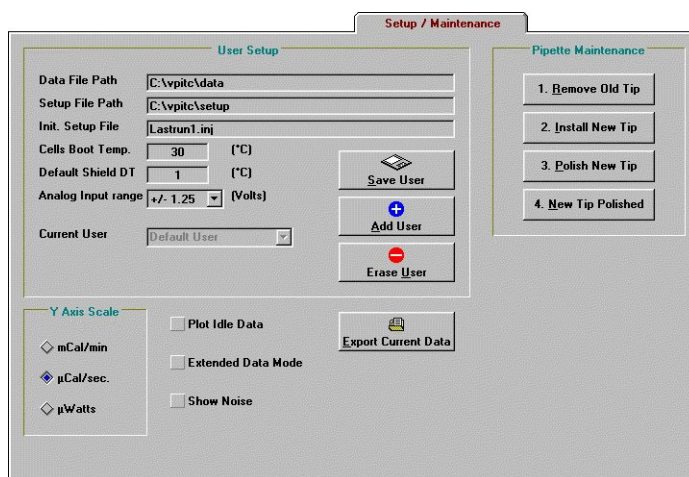

To enable additional users, select the *Add User* button and enter a user name in the text box and click OK.

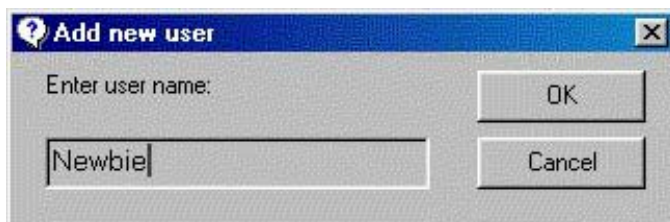

The following descriptions detail the parameters that you may wish to alter for each user.

### ***Data File Path***

Indicates the complete path (excluding file name) where all VP-ITC data files will be saved. The specified path should be located on a hard drive and not on any floppy or CD-ROM drives. Probably most convenient will be to create and use sub directories off of the /data sub directory which was created by the VPViewer installation program. This setting may only be changed while the VP-ITC is in the Thermostatting state. To change the current data file path, double click on the existing path text and a dialog box will open allowing you to change the current path.

### ***Setup File Path***

Indicates the complete default path (excluding file name) where all VP-ITC setup files will be written to. The specified path should be located on a local hard drive and not on any floppy or CD-ROM or network drives. To change the current setup file path, double click on the existing path text and a dialog box will open allowing you to change the current path.

### ***Init. Setup File***

Specifies the initial setup file that will be loaded into the experimental control window the first time it is opened. Specifying a \*.inj file here will result in an initial ITC. Lastly, specifying the initial setup file as LastRun1.inj will result in the last run parameters that were executed on the ITC cell to be loaded at startup.

### ***Cells Boot Temp. (Deg. C)***

Determines the initial thermostat temperature upon launching the VPViewer application. Immediately after starting VPViewer, the system will enter the Thermostatting state, go to the boot temperature and thermostat there until the user takes action which causes the VP-ITC to change temperatures (changing current thermostat temperature or beginning an experiment).

### ***Default Shield DT (Deg. C)***

The Default Shield DT (1 deg C.) should be used. Do not change this value without first consulting with a MicroCal engineer.

### ***Analog Input range (Volts)***

Click on the arrow for the Analog Input range drop down list. The default value of +/- 1.25 Volts is the most sensitive range for input data and should normally be selected. If you expect an experiment will be strongly endothermic or exothermic you should select a larger input voltage range to prevent the peaks from being clipped by an out of range signal.

