

# Chem0303 WS15/16 - Übung 3

09.12.2015

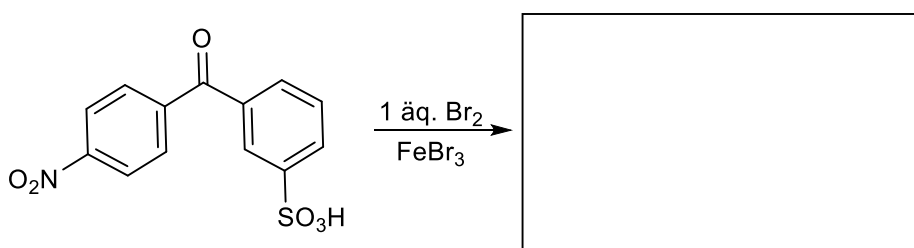

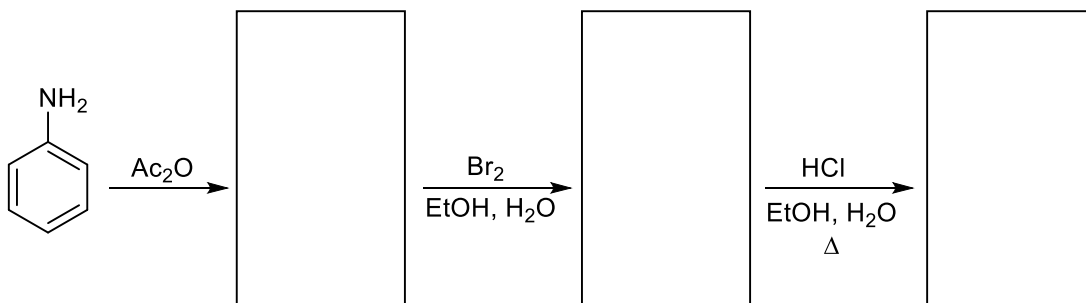

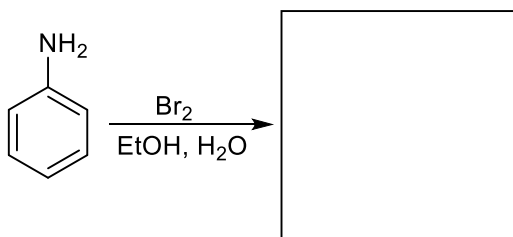
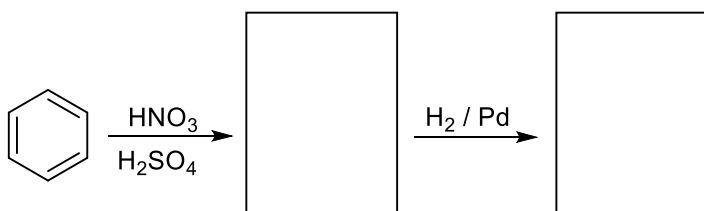
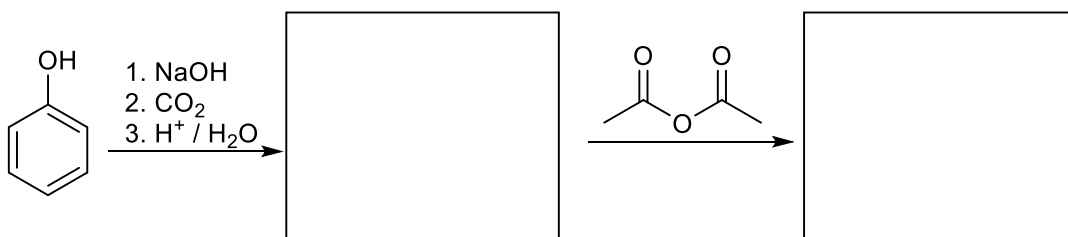
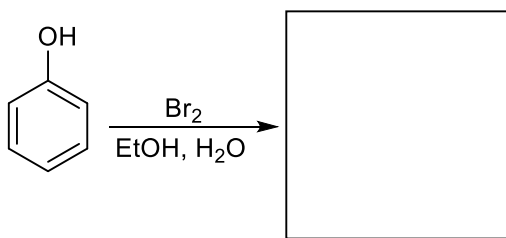
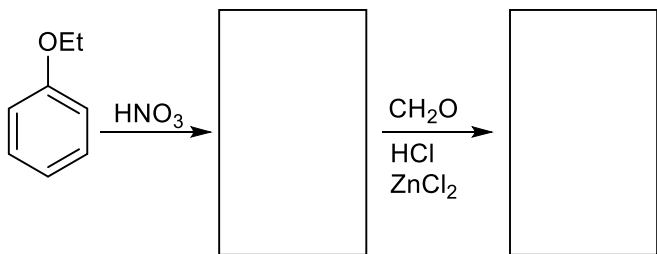
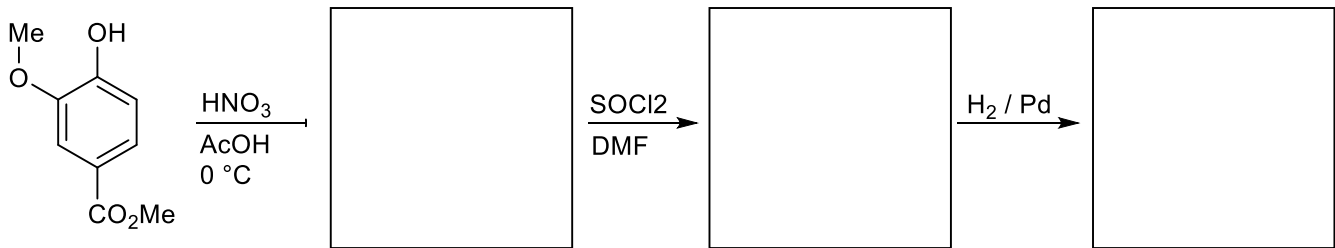
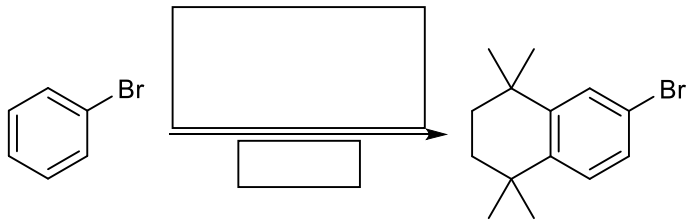
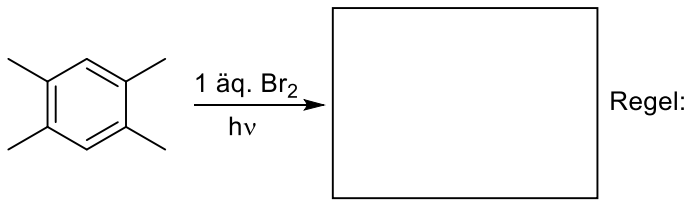
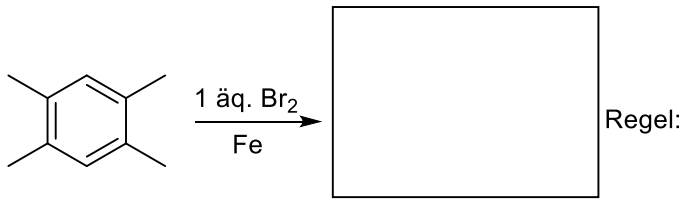
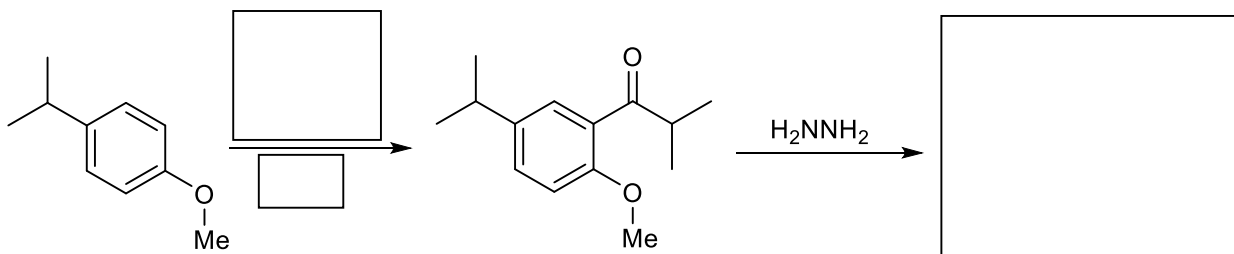
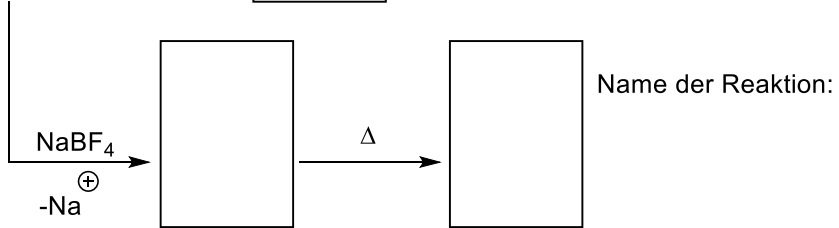
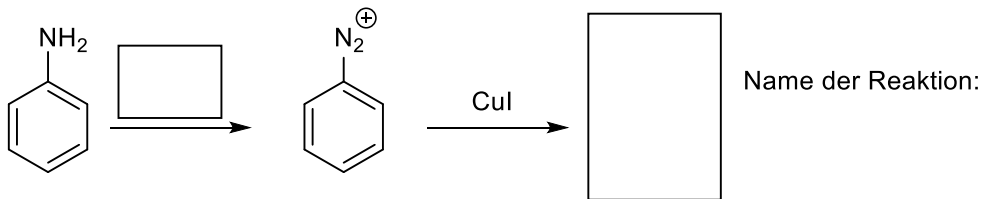
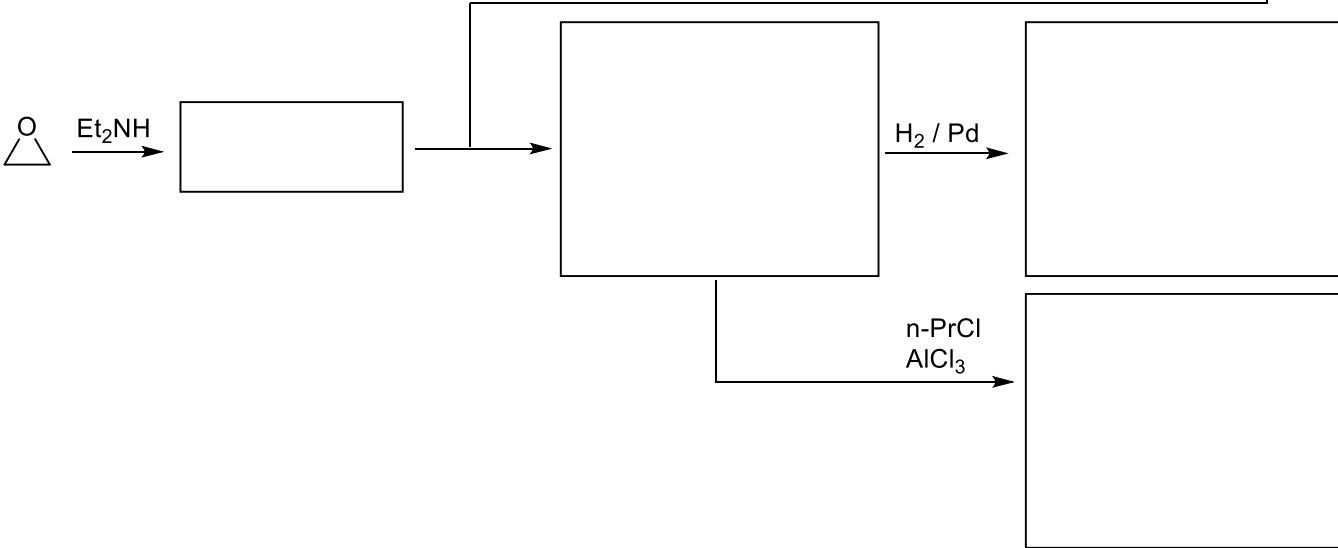
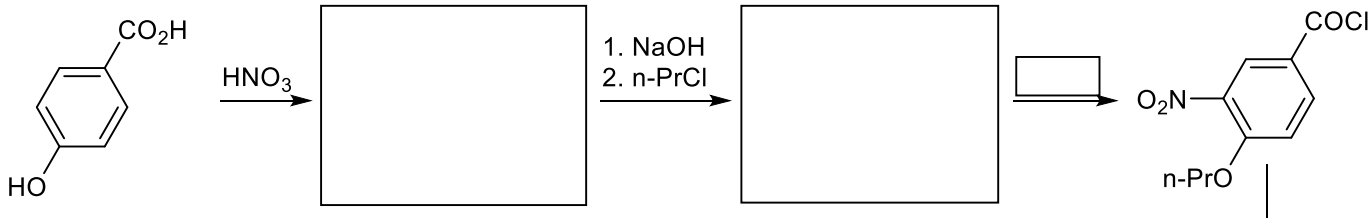

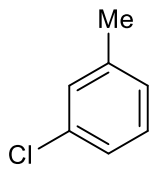
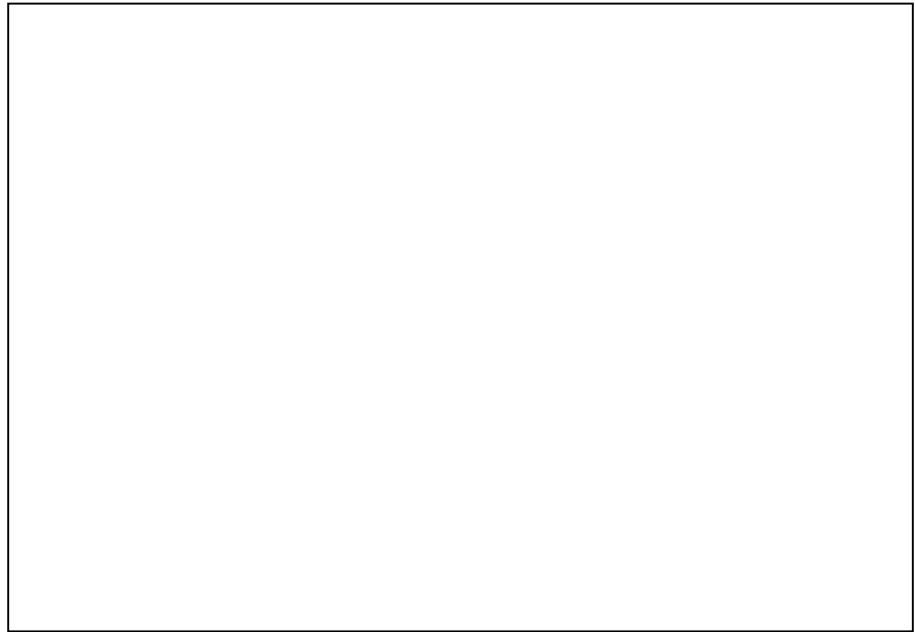
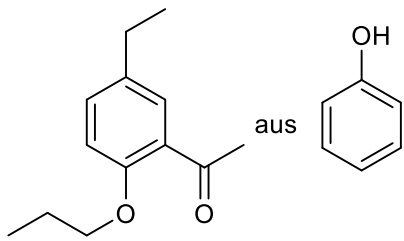

1. LDA  
 2. H<sub>2</sub>O

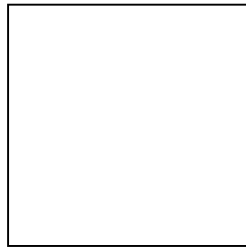
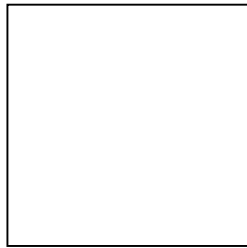

Mechanismus

